

MINIATURE MEMS VARIABLE OPTICAL ATTENUATOR

OVERVIEW

The **sercalo** VX series are miniature opto-mechanical variable optical attenuators (VOA) for fiber optic communication systems and submodules. The non-latching attenuator allows for the continuous adjustment of the attenuation with a 0 – 5 V control voltage. The highly reliable attenuation mechanism is based on a micromechanical shutter and features below 20 ms response time and below 1.0 dB insertion loss. The VOA is available in single and dual variants.

The plastic package is one of the smallest in the industry. It is optimized for low cost production while maintaining high reliability comparable to a solid state device. The component is designed to meet Telcordia 1221 quality standards.

FEATURES

- 23 x 10 x 6 mm size
- low PDL
- very fast
- 0-5 V control
- single or dual channel

APPLICATIONS

- Power management in DWDM transceivers
- Amplifier Gain Control
- Optical Subsystems
- Array integration

Contact:

Sercalo microtechnology ltd
Landstrasse 151, 9494 Schaan
Principality of Liechtenstein
Tel. +423 237 57 97 Fax. +423 237 57 48
www.sercalo.com e-mail: info@sercalo.com

Ordering Information:



800 Village Walk #316
Guilford, CT 06437
Ph: 203-401-8093

Email orders to: sales@xsoptix.com
Fax orders to: 800-878-7282

DESCRIPTION

The **Sercalo** VX variable optical attenuators are composed of an optical subsystem and an electrical driver interface. The optical attenuation is set by a silicon MEMS chip, on which a mirror can be moved in and out of the optical path by electrostatic actuation.

The internal driver interface converts the applied 5 V supply into a negative bias voltage and a positive high voltage. The positive voltage powers an operational amplifier. The attenuation is set by a 0-5 V input signal. This input signal is connected to the non inverting input of the operational amplifier which drives the electrostatic actuator of the MEMS variable optical attenuator (*Figure 9*). This high voltage design of the MEMS chip results a fast, robust and vibration insensitive attenuator.

The VX attenuators are available in single channel and dual channel variants. The standard VX attenuator achieves minimum insertion loss at 0 V input voltage. When power is removed the insertion loss is roughly 0.5 dB higher than the minimum insertion loss (at 0 V when power is on).

TECHNICAL SPECIFICATIONS

	Unit	Min	Typ	Max
VOA				
Wavelength Range	nm	1240		1640
Insertion Loss	dB		0.35	1.0 ¹
Maximum Attenuation	dB	30		
Maximum Input Power	mW			130
Backreflection	dB		55	50
Polarisation Dependent Loss at 10 dB	dB		0.08	0.15
Polarisation Dependent Loss at 20 dB	dB		0.13	0.25 ²
Wavelength dependent loss at 10 dB ³	dB		0.2	0.5
Wavelength dependent loss at 20 dB ³	dB		0.5	1.2
Temperature dependent loss at 1 dB	dB			0.4
Temperature dependent loss at 10 dB	dB			2
Temperature dependent loss at 20 dB	dB			4
Repeatability	dB			0.3 ⁴
Response Time	ms			20
Durability	cycles		no wear out	
Package				
Voltage	V	4	5	5.25
Power Consumption	mW		5	30
Operation Temperature	°C	0		70
Storage Temperature	°C	-40		70
Size (L x W x H)	mm		23.2 x 10.1 x 5.9	

¹without connectors ² for dual variant 0.35 dB max @ 20 dB ³ between 1530 -1570 nm

⁴ for constant polarisation and temperature.

ORDERING INFORMATION

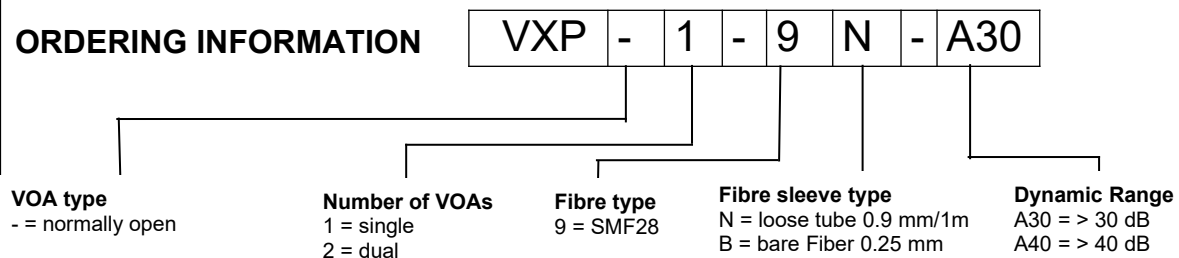

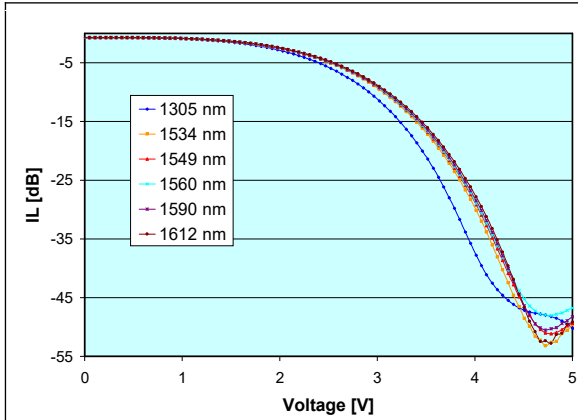

Figure 1: Voltage attenuation curve

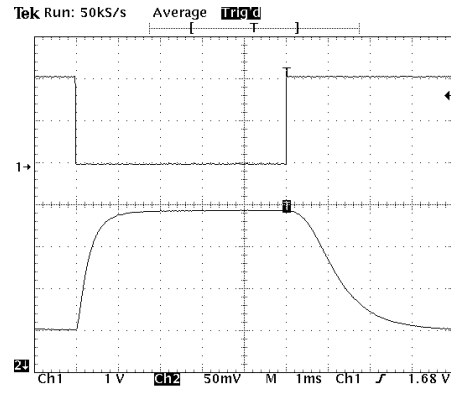

Figure 2: response time to a 1 to 3 V step

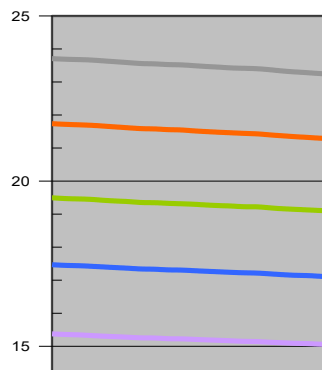

Figure 5: Wavelength Flatness of attenuation

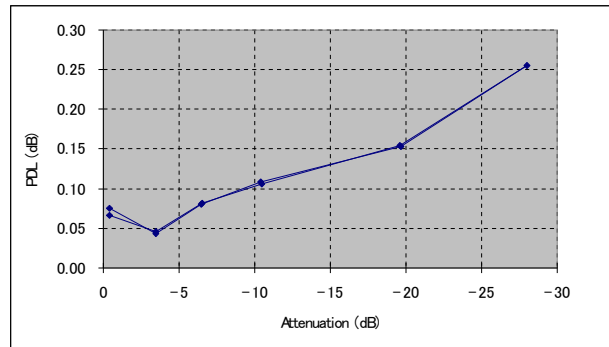

Figure 6: PDL as a function of attenuation

Contact Pins:
 Length: 4 +/- 1mm
 Diameter: 0.45-0.5 mm
 Centering: 0.2 mm
 1: Supply +5 V
 2: Ground
 3: Signal in 0-5 V

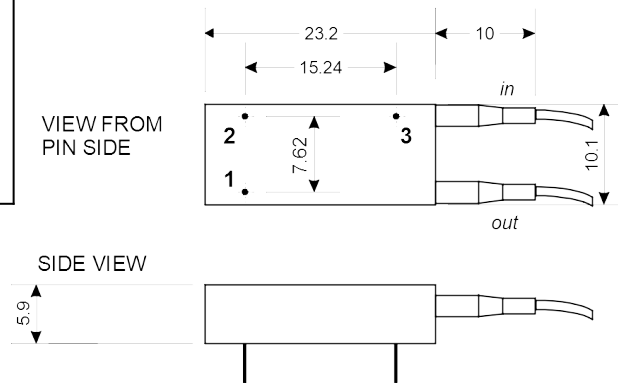

Figure 7: VXP-1: mechanical outline

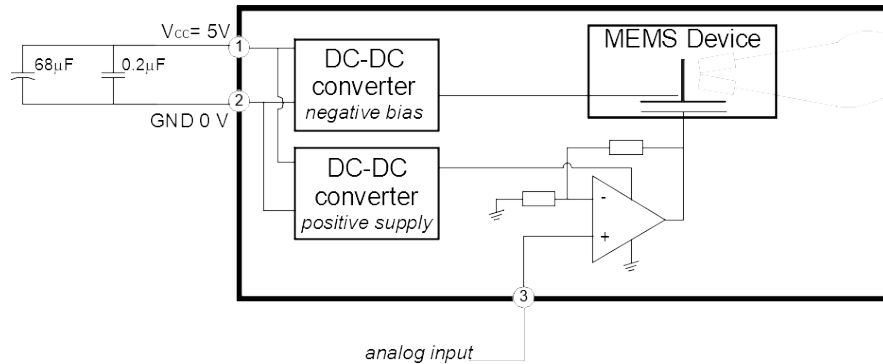

Figure 9: Schematic Electrical Diagram