

MULTI MODE LASER DIODES

Broad Area Laser

General Product Information

Product	Application
808 nm Broad Area Laser	Sensing
for High Energy Pulse Mode Operation	
sealed TO Housing	

Absolute Maximum Ratings

Parameter	Symbol	Unit	min	typ	max
Storage Temperature	T_S	°C	-40		85
Operational Temperature at Case	T_C	°C	-20		80
Peak Current	$I_{F Peak}$	A			21
Reverse Voltage	V_R	V			2
Peak Output Power	$P_{opt Peak}$	W			21
Forward Voltage at Peak	V_F	V			4

Measurement Conditions / Comments

Every condition of the Absolute Maximum Ratings has to be kept during operation

see Pulse Mode Conditions

see Pulse Mode Conditions

see Pulse Mode Conditions

Recommended Operational Conditions

Parameter	Symbol	Unit	min	typ	max
Operational Temperature at Case	T_C	°C	0		75
Forward Current	$I_{F Peak}$	A			20
Output Power	$P_{opt Peak}$	W		18	

Measurement Conditions / Comments

see Pulse Mode Conditions

see Pulse Mode Conditions

Characteristics at 25° C at Begin Of Life

Parameter	Symbol	Unit	min	typ	max
Center Wavelength	λ_C	nm	793	808	823
Spectral Width (FWHM)	$\Delta\lambda$	nm		3	
Temperature Coefficient of Wavelength	$d\lambda / dT$	nm / K		0.3	
Peak Output Power @ $I_F = 20$ A	$P_{opt Peak}$	W		18	
Threshold Current	I_{th}	A		1.5	
Differential Series Resistance	R_S	Ω		0,07	

Measurement Conditions / Comments

see Pulse Mode Conditions

see Pulse Mode Conditions



MULTI MODE LASER DIODES Broad Area Laser

Package Dimensions

Parameter	Symbol	Unit	min	typ	max
Height of Emission Plane	d_{EP}	mm		3.65	
Excentricity of Emission Center	R	mm			0.15
Pin Length	l	mm		14.0	

Measurement Conditions / Comments

reference plane A: top side of TO header
reference B: center of outer diameter of head

Pin Assignment

- 1 Laser Diode Anode, Case
- 2 not connected
- 3 Laser Diode Cathode

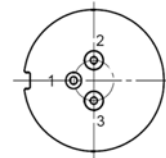
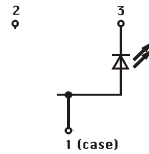

Package Drawings

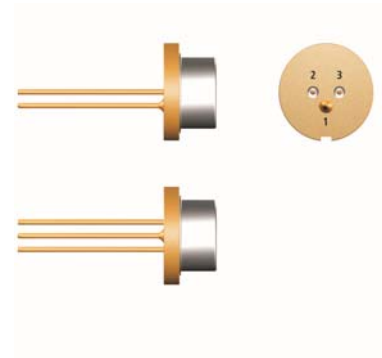
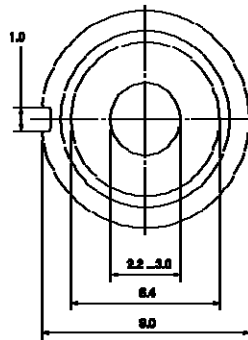
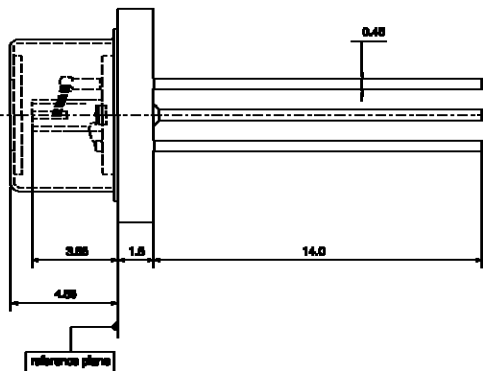

MULTI MODE LASER DIODES Broad Area Laser

Typical Measurement Results

Spectrum

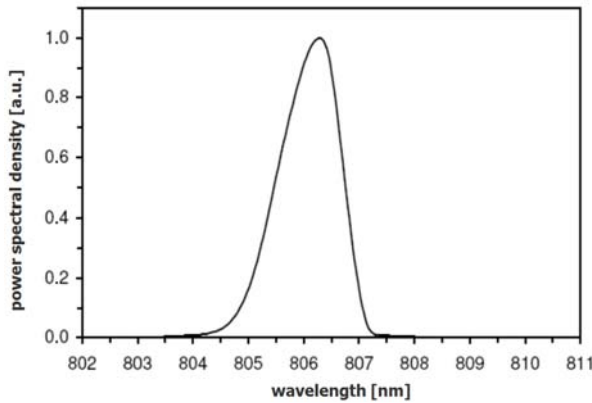

Performance figures, data and any illustrative material provided in this specification are typical and must be specifically confirmed in writing by eagleyard Photonics before they become applicable to any particular order or contract. In accordance with the eagleyard Photonics policy of continuous improvement specifications may change without notice.

Unpacking, Installation and Laser Safety

Unpacking the laser diodes should only be done at electrostatic safe workstations (EPA). Though protection against electro static discharge (ESD) is implemented in the laser package, charges may occur at surfaces. Please store this product in its original package at a dry, clean place until final use. During device installation, ESD protection has to be maintained.

The BAL diode type is known to be sensitive against thermal stress. Operating at moderate temperatures on proper heat sinks will contribute to a long lifetime of the diode.

The laser emission from this diode is close to the invisible infrared region of the electromagnetic spectrum. Avoid direct and/or indirect exposure to the free running beam. Collimating the free running beam with optics as common in optical instruments will increase threat to the human eye.

Each laser diode will come with an individual test protocol verifying the parameters given in t

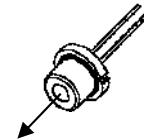

Laser Emission

