



EYP-TPA-0795-02000-4006-CMT04-0000

Revision 0.92

2019-08-01

TAPERED AMPLIFIERS Semiconductor Optical Amplifier

General Product Information

Product	Application
795 nm Tapered Amplifier	Spectroscopy
C-Mount Package	

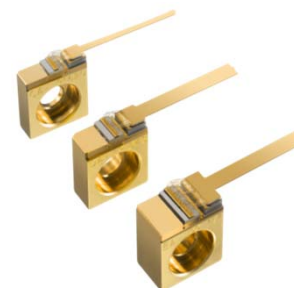

Absolute Maximum Ratings

Parameter	Symbol	Unit	min	typ	max
Storage Temperature (non condensing)	T_S	°C	-40		85
Operational Temperature at Case (non cond.)	T_C	°C	0		50
Forward Current	I_F	A			4.2
Reverse Voltage	V_R	V			2
Output Power	P_{opt}	W			2.2

Measurement Conditions / Comments

Stress in excess of one of the Absolute Maximum Ratings may damage the laser. Please note that a damaging optical power level may occur although the maximum current is not reached. These are stress ratings only, and functional operation at these or any other conditions beyond those indicated under Recommended Operational Conditions is not implied.

Recommended Operational Conditions

Parameter	Symbol	Unit	min	typ	max
Operational Temperature at Case	T_C	°C	5		40
Forward Current	I_F	A			4.0
Input Power	P_{input}	mW	10		50
Output Power	P_{opt}	W			2.0

Measurement Conditions / Comments

non condensing

with proper injection from a seed laser

Characteristics at $T_{LD} = 25\text{ °C}$ at BOL

Parameter	Symbol	Unit	min	typ	max
Design Wavelength	λ_C	nm		795	
Gain Width (FWHM)	$\Delta\lambda$	nm		20	
Temperature Coefficient of Wavelength	$d\lambda / dT$	nm / K		0.3	
Operational Current @ $P_{opt} = 2.0\text{ W}$	$I_{op\ Gain}$	A			4.0
Output Power	P_{opt}	W	2.0		
Amplification	G	dB		20	
Cavity length	L_C	μm		4000	

Measurement Conditions / Comments

see images on page 4

with proper injection from a seed laser

at recommended maximum forward current

EYP-TPA-0795-02000-4006-CMT04-0000

Revision 0.92

2019-08-01

TAPERED AMPLIFIERS Semiconductor Optical Amplifier

Characteristics at $T_{LD} = 25\text{ }^\circ\text{C}$ at BOL cont'd

Parameter	Symbol	Unit	min	typ	max
Reflectivity at Front Facet	R_{ff}			3·10 ⁻⁴	1·10 ⁻³
Reflectivity at Rear Facet	R_{rf}			3·10 ⁻⁴	1·10 ⁻³
Input Aperture (at rear side)	d_{in}	μm		3	
Output Aperture (at front side)	d_{out}	μm		210	
Astigmatism	A	μm		700	
Input Divergence parallel ($1/e^2$)	$\Theta_{in }$	$^\circ$		23	
Input Divergence perpendicular ($1/e^2$)	$\Theta_{in\perp}$	$^\circ$		42	
Output Divergence parallel ($1/e^2$)	$\Theta_{out }$	$^\circ$		17	
Output Divergence perpendicular ($1/e^2$)	$\Theta_{out\perp}$	$^\circ$		42	
Polarization				TM	

Measurement Conditions / Comments

estimated at recommended maximum forward current

E field perpendicular to junction plane

Typical Measurement Results

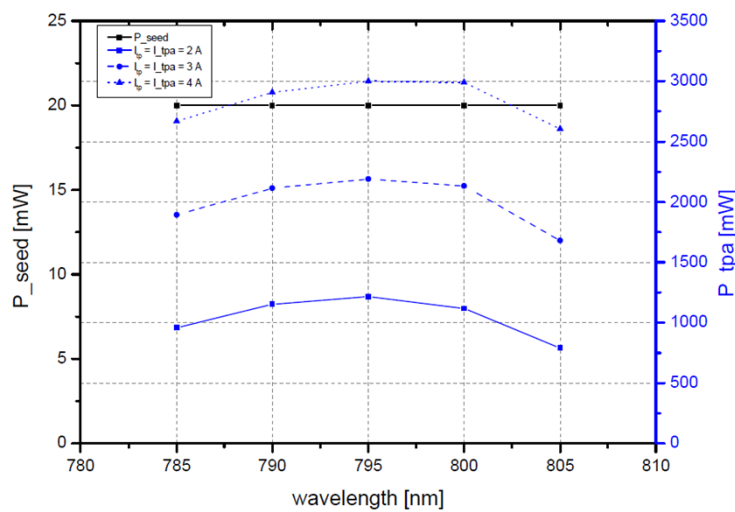

Performance figures, data and any illustrative material provided in this specification are typical and must be specifically confirmed in writing by eagleyard Photonics before they become applicable to any particular order or contract. In accordance with the eagleyard Photonics policy of continuous improvement specifications may change without notice.

EYP-TPA-0795-02000-4006-CMT04-0000

Revision 0.92

2019-08-01

TAPERED AMPLIFIERS Semiconductor Optical Amplifier

Package Dimensions

Parameter	Symbol	Unit	min	typ	max
Height of Emission Plane	h	mm	7.05	7.10	7.20
C-Mount Thickness	t	mm		4.05	

Measurement Conditions / Comments

Package Pinout

Mounting Wire	Cathode (-)
Housing	Anode (+)

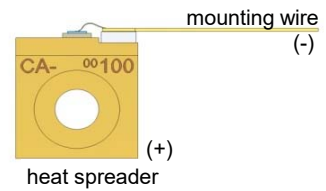

Package Drawings

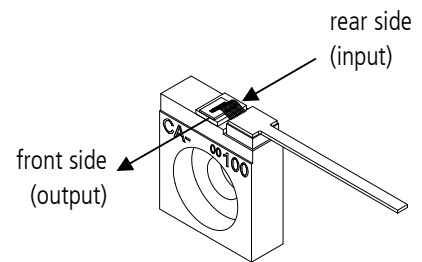
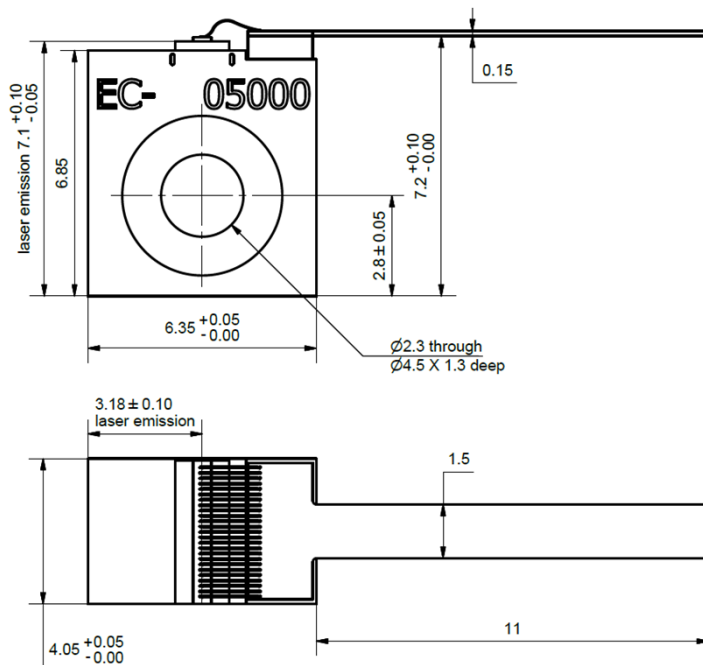

AIZ-18-0413-1535

EYP-TPA-0795-02000-4006-CMT04-0000

Revision 0.92

2019-08-01

TAPERED AMPLIFIERS Semiconductor Optical Amplifier

Unpacking, Installation and Laser Safety

Unpacking the laser diodes should only be done at electrostatic safe workstations (EPA). Though protection against electro static discharge (ESD) is implemented in the laser package, charges may occur at surfaces. Please store this product in its original package at a dry, clean place until final use. During device installation, ESD protection has to be maintained.

The TPA diode type is known to be sensitive against thermal stress. It should not be operated without appropriate injection from a seed laser. Operating at moderate temperatures on proper heat sinks will contribute to a long lifetime of the diode. The chip should be protected against moisture. A water vapor content below 5000 ppm is recommended for applications with high reliability requirements.

The laser emission from this diode is close to the invisible infrared region of the electromagnetic spectrum. Avoid direct and/or indirect exposure to the free running beam. Collimating the free running beam with optics as common in optical instruments will increase threat to the human eye.

Each laser diode will come with an individual test protocol verifying the parameters given in this document.

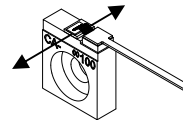

Laser Emission

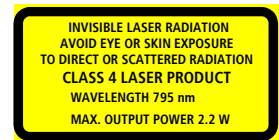

IEC-60825-0



Complies with 21 CFR 1040.10 and 1040.40