

Ordering Information:



800 Village Walk #316
Guilford, CT 06437
Ph: 203-401-8093

Email orders to: sales@xsoptix.com
Fax orders to: 800-878-7282

XDAC-120U-R4G8

SPECIFICATION SHEET AND MANUAL 2024

CE RoHS

nicslab

Version: 8.5

Date: 12 June 2024

Important Notice and Disclaimer:

No part of this document may be reproduced in any form or by any means (including electronic storage and retrieval or translation into a foreign language) without prior agreement and written consent from Nicslab. No responsibility is assumed by Nicslab for its use, nor for any infringements of patents or other rights of third parties that may result from its use. Trademarks and registered trademarks are the property of their respective owners.

This product is designated for skilled users. You are entirely responsible for (1) choosing the appropriate Nicslab products for your operation; (2) designing, validating, and testing your operation; and (3) ensuring your operation meets applicable standards and any other safety, security, or other requirements.

Copyright © 2023, Nicslab.

Safety Note

Do not operate this product in any manner not specified by Nicslab. Failure to comply with these precautions or with specific warnings or instructions elsewhere in this manual violates safety standards of design, manufacture, and intended use of the instrument. Nicslab assumes no responsibility for any damage caused by mishandling that is beyond normal usage defined in this manual of this product.

Before Applying DC Power Supply

Verify that the DC power supply is in good condition and safe to use. It is imperative to use ONE DC power supply as a source power for this product and the input voltage is no more than 36 V or it can impair this product. Make all connections to the unit before applying power.

Do Not Discard the Instrument Cover

Only authorized personnel from Nicslab should remove the instrument cover.

Do Not Alter the Instrument

Do not put any unauthorized parts or modify the instrument without Nicslab approval and warranty.

Caution

This symbol indicates the hazard of any operating procedure, practice, or the like that, if not correctly performed or adhered to, could result in damage to the product or loss of important data.

Contents

List of Tables	4
List of Figures	4
1. Introduction	5
2. Hardware	7
Specification Conditions	7
Hardware Requirement	7
Box Descriptions	8
XDAC-120U-R4G8 Specifications	11
Hardware Installation	14
3. Software and Graphical User Interface (GUI)	15
Software Requirement	15
Software Installation	15
Graphical User Interface (GUI)	15
Initializing the GUI	18
Premium Upgrade	18
Constant Current Mode (CC) Mode	20
Constant Voltage Mode (CV) Mode	20
Value Increment Setting	21
Save and Upload	21
Sequence Automation	23
Record	24
Settings	25
4. Operating XDAC through the SCPI command	30
Python Installation (Example)	30
Run Python Code (Example)	31
Python Function (Example)	33
SCPI Commands	37
5. System Shutdown	41
6. Troubleshooting	42
7. Warranty	43
8. Compliance	43
9. Contact	43

List of Tables

Table 1. Checklist Items	6
Table 2. Specification Conditions	7
Table 3. DAC Voltage Performance Specification	11
Table 4. DAC Current Performance Specifications	12
Table 5. Voltage Control Resolution	13
Table 6. Current Control Resolution	13
Table 7. Troubleshooting	42

List of Figures

Figure 1. XDAC-120U-R4G8 System Diagram	6
Figure 2. Product Dimension	8
Figure 3. Front and Back Panel	9
Figure 4. GUI	16

1. Introduction

Nicslab XDAC-120U-R4G8 system is a versatile multichannel source measurement system. The XDAC-120U-R4G8 supports multiple voltage/current sourcing and voltage/current measurement. The system is suitable for sourcing and measuring low-power applications from simple electronic circuits to complex photonic integrated circuits.

The XDAC-120U-R4G8 provides independent 120 channels controlled by Graphical User Interface (GUI) and Standard Commands for Programmable Instruments (SCPI) through an Ethernet port. The system has two modes: Constant Current (CC) ranging from 0 to 300 mA per channel and Constant Voltage (CV) ranging from unipolar 0 – 5 Volt, 0 – 10 Volt, 0 – 20 Volt, and 0 – 34 Volt (please check your feature selection).

The features for XDAC-120U-R4G8 in detail are:

- 16-bits voltage control, see the resolution at Table 5.
- 16-bits current control, see the resolution at Table 6.
- Enable voltage and current range configuration through software (technology that enables the user to select the output range with software without losing control of the high-resolution feature).
- Flexible output configuration with 16-bit resolution unipolar 0 – 5 V, 0 – 10 V, 0 – 20 V and 0 – 34 V (*Premium Upgrade*).
- Flexible current output configuration with 16-bit resolution 0 – 300 mA, 0 – 200 mA, 0 – 100 mA, 0 – 50 mA, 0 – 25 mA, 0 – 12.5 mA, 0 – 6.25 mA and 0 – 3.125 mA (*Premium Upgrade*) – *Firmware version 4.1.1.1 and up*.
- Flexible reading speed configuration for voltage and current with 8 increment value. – *Firmware version 4.1.1.1 and up*.
- Measurement time for single channel: 104 ms.
- Intuitive GUI.
- Multi-connectors according to your application (Optional).
- The maximum power output per channel is 10 watts.
- Real time voltage reading (16-bits resolution = 1.25 mV).
- Real time current reading (16-bits resolution = 5 μ A).
- Save function to create a database.
- Upload function to generate the registrable voltage and current pattern.
- Sequence function for continuous voltage and current.
- Short circuits protection.
- SCPI command support (Python, Matlab, C# and LabVIEW).
- SCPI Library (*Premium Upgrade*).
- Windows, Mac, and Linux support.

- Ethernet Port.

The XDAC-120U-R4G8 needs to be connected with direct current (DC) power first then you can plug into the Device-Under-Test (DUT) or multi-connector. The voltage/current can be controlled through GUI or SCPI command via an Ethernet port (Ethernet to USB port converter).

The system diagram is as follows:

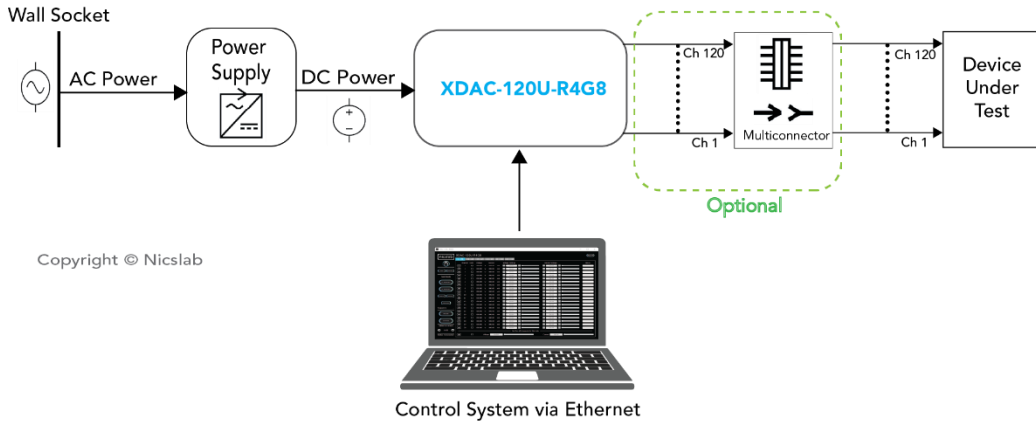

Figure 1. XDAC-120U-R4G8 System Diagram

The package should include the following items:

Table 1. Checklist Items

No	Item	Qty (pc)	Checklist
1	XDAC-120U-R4G8 Box	1	
2	DC power line cord (Red, Black)	2	
3	USB 2.0 to ethernet adapter	1	
4	Multi-connector 6 (Optional)	1	
5	Ribbon rainbow cable (Optional)	6	
6	Ethernet cable	1	
7	USB flash disk	1	
8	Inside USB flash disk: a. GUI b. Specification & Manual c. Test Report d. Serial key (Upgrade) e. XDAC key f. Software Library (Premium) g. Comma-separated values (CSV) template (upload, demo sequence)	1	

2. Hardware

Specification Conditions

The operating and measurement conditions are under the following conditions:

Table 2. Specification Conditions

Items	Conditions
Room Temperature	0 ~ 40 °C
Humidity	5 ~ 80 % (No Condensing)
Power Supply Input	DC Supply Max 36 V (potential at red & black DC in). Power up minimum 72 watt (36 V, 2A power supply setting). Required headroom 1.4 – 2 V.
Waterproof/Dustproof	To be operated under room condition
Calibration period	2 years

Note: To minimize the possibility of overheating the device, it is recommended that the supply voltage value should be the maximum output to be generated + 3 volts. For example, if you have a DUT that needs to be driven by 100 mA current with a voltage of 10 V, then the recommended power supply setting is 10 + 3 Volts which is 13 Volts.

Hardware Requirement

The requirements for the PC/laptop to be used for this product installation are:

- Resolution Min. 1024 x 768 pixel
- Hard disk Min. 500 MB of available free space (32-bit and 64-bit operating system)
- USB Port USB 2.0
- RAM Min. 2 GB
- CPU 2.4 GHz or faster
- Ethernet port or internet connection via router

Box Descriptions

The box size is 232 (W) x 450 (L) x 102 (H) mm, with a weight of 7.9 kg, as shown in the pictures below:

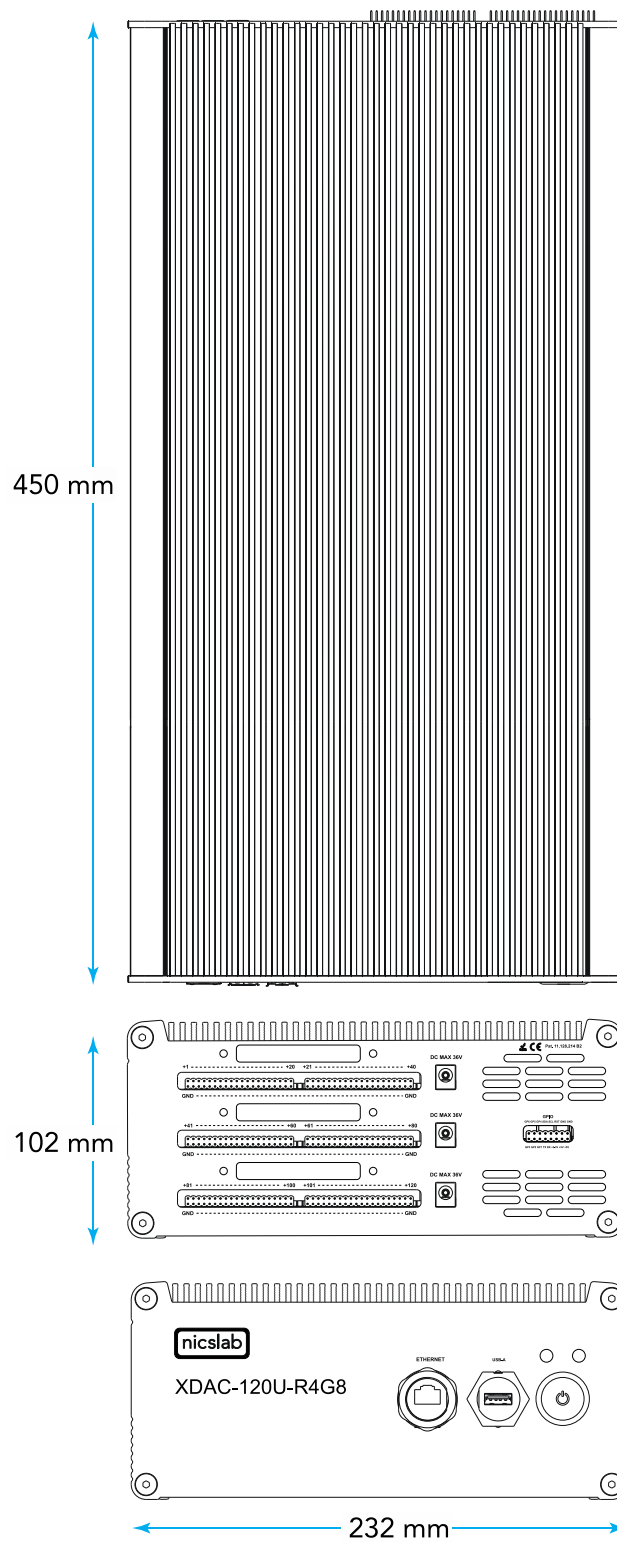

Figure 2. Product Dimension

The details of the front and back panel of the box are described below:

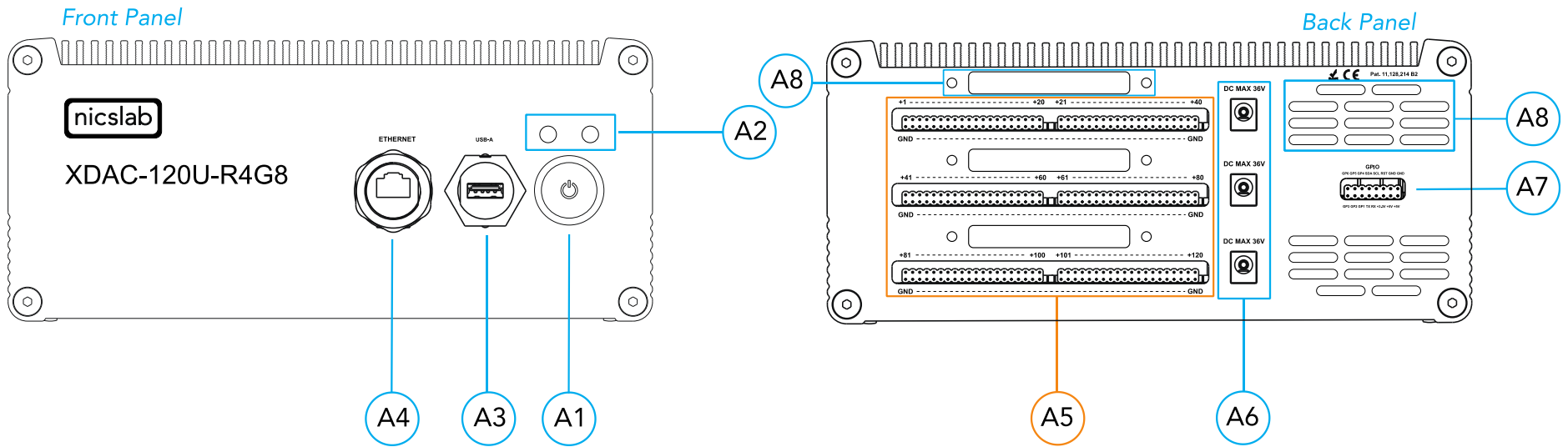

Figure 3. Front and Back Panel

Note:

A1	Power Switch	Turns the instrument on or off. Caution Before turning OFF please close the GUI or type shutdown (SCPI command) to minimize the risk of corrupting the system file (such as data loss).
A2	Indicator Light	Blue -> Power Indicator. Green -> Serial Transfer Data Active.
A3	USB-A	USB port type A.
A4	Ethernet	Use an ethernet cable to connect, or an ethernet to USB port converter if the computer doesn't have the ethernet port.
A5	Pin Output (40 channels per row)	To connect to Device Under Test (DUT) using cable or multi-connector. Row 1: Channel 1 to 40 Row 2: Channel 41 to 80 Row 3: Channel 81 to 120
A6	Input DC Max 36V	Caution Please follow the safety notice on your DC power supply. USE ONLY ONE DC POWER SUPPLY and the input is no more than 36 V. The XDAC will not power up if the current from the power supply is too low (minimum 2 A). Black cable inserts to negative terminal (0 V) Red cable inserts to positive terminal (36 V)
A7	GPIO	You may use for external control and direct monitoring of the microprocessor.
A8	Airflows	For air circulation inside the box.

XDAC-120U-R4G8 Specifications

The performance specifications of Digital Analog Converter (DAC) voltage are listed in Table 3 below:

Table 3. DAC Voltage Performance Specification

No	Parameter	Min	Typ	Max	Unit	Test conditions/comments
1	Resolution	16			Bits	
2	Integral nonlinearity (INL)	-1	± 0.5	1	LSB	All ranges
3	Differential Nonlinearity (DNL)	-1	± 0.5	1	LSB	Specified 16-bit monotonic
4	Total unadjusted error	-0.1	± 0.01	0.1	%FSR	All ranges
5	Unipolar offset error	-0.03	± 0.015	0.03	%FSR	All unipolar ranges
6	Unipolar zero-code error	0	0.04	0.1	%FSR	All unipolar ranges
7	Full-scale error	-0.2	± 0.075	± 0.2	%FSR	All ranges
8	Gain error	-0.1	± 0.02	0.1	%FSR	All ranges
9	Unipolar offset error drift		±2		ppm of FSR/°C	All unipolar ranges
10	Gain error drift		±2		ppm of FSR/°C	All ranges
11	Output voltage drift over time		5		Ppm of FSR	T _A = 40 °C, Full-scale code, 1900 hours
DYNAMIC PERFORMANCE						
12	Output Voltage Settling Time		12		µs	¼ to ¾ and ¾ to ¼ scale setting time to ± 1 LSB, ±10 V range, R _L = 5 kΩ, C _L = 200 pF
13	Slew Rate		4		V/µs	All ranges except 0 to 5 V
14	Power-on glitch magnitude		0.3		V	Power-down to active DAC output, ±20 V range, Midscale code, R _L = 5 kΩ, C _L = 200 pF
15	Output noise		15		µV p-p	0.1 Hz to 10 Hz, Midscale code, 0 to 5 V range
16	Output noise density		78		nV/√Hz	1 kHz, Midscale code, 0 to 5 V range
17	AC PSRR		1		LSB/V	Midscale code, frequency = 60 Hz, amplitude 200 mVpp superimposed on V _{DD} , V _{CC} , or V _{SS}
18	DC PSRR		1		LSB/V	Midscale code, V _{DD} = 5 V, V _{CC} = 20 V ±5 %, V _{SS} = 20 V
19	Code change glitch impulse		4		nV-s	1 LSB change around the major carrier, 0 to 5 V range
20	Channel to Channel AC crosstalk		4		nV-s	0 to 5 V range. Measured channel at midscale. Full-scale swing on all other channels.
21	Channel to Channel DC crosstalk		0.25		LSB	0 to 5 V range. Measured channel at midscale. All other channels at full-scale.
22	Digital feedthrough		1		nV-s	0 to 5 V range, Midscale code, F _{SCLK} = 1 MHz

The performance specifications of the Digital Analog Converter (DAC) current are listed in Table 4 below:

Table 4. DAC Current Performance Specifications

No	Parameter	Min	Typ	Max	Unit	Test conditions/comments
1	Resolution	16			Bits	
2	Monotonicity	16			Bits	
3	Differential Nonlinearity		± 0.2	± 1	LSB	
4	Integral Nonlinearity		± 12	± 64	LSB	
5	Offset Error Current		± 0.1	± 0.4	%FSR	
6	V= Temperature Coefficient		± 10		ppm/°C	
7	Gain Error		± 0.3	± 0.9	%FSR	300 mA Range
8	Gain Temperature Coefficient		30		%FSR	FSADJ = VCC
9	Total Unadjusted Error		± 0.4	± 1.4	%FSR	300 mA Range
10	Power Supply Rejection Ratio		± 2.2		LSB	100 mA; I _{OUT} = 50 mA
11	DC Crosstalk		±14		LSB	Due to a 200 mW Change in Dissipated Power
12	DC Performance					
13	V _{DROPOUT}		1.15	1.751	V	300 mA Range
14	Hi-Z Output Leakage Current		0.1	1	µA	
AC CHARACTERISTIC						
16	t _{SET}		4.7		µs	Settling time, Full-Scale 200 mA range
17	Glitch Impulse		180		pA.s	At Mid-Scale Transition, 200 mA Range
18	DAC-to-DAC Crosstalk		150		pA.s	100 mA to 200 mA Step, R _{load} = 15 Ω
19	I _{noise}					Output Current Noise Density Internal Reference, I _{out} = 150 mA, R _{load} = 4 Ω, C _{load} = 10 µF
20			12			f = 1 kHz
21			5		nA√Hz	f = 10 kHz
22			0.5	n	nA√Hz	f = 100 kHz
23			0.05		nA√Hz	f = 1 MHz

The voltage control resolution is listed in Table 5 below. The resolution is 16-bits and have different value for each range. The default range is 0 – 40 V (34 V) and can be adjusted in GUI premium version.

Table 5. Voltage Control Resolution

No	Range	Resolution
1	0 – 40 V (34 V)	0.6 mV
2	0 – 20 V	0.3 mV
3	0 – 10 V	150 μ V
4	0 – 5 V	76 μ V

The current control resolution is listed in Table 6 below. The resolution is 16-bits and have different value for each range. The default range is 0 – 300 mA and can be adjusted in GUI premium version.

Table 6. Current Control Resolution

No	Range	Resolution
1	0 – 300 mA	4.5 μA
2	0 – 200 mA	3.05 μ A
3	0 – 100 mA	1.52 μ A
4	0 – 50 mA	0.76 μ A
5	0 – 25 mA	0.38 μ A
6	0 – 12.5 mA	0.19 μ A
7	0 – 6.25 mA	95 nA
8	0 – 3.125 mA	47 nA

Note: Current range configuration only available on Firmware version 4.1.1.1 and up, for earlier versions, the current range configuration cannot be changed at 300 mA.

Hardware Installation

This section describes how to install XDAC-120U-R4G8 and how to connect your Device Under Test (DUT) to the output terminals.

The steps are as follows:

1. Precondition step: connect to the DC power supply (max 36 V). Make certain that the DC power supply is always 'ON'.
2. Connect a USB cable to your workstation (PC/Laptop) via Ethernet Port or USB A Ethernet Network Adaptor.
3. Install the software/GUI (see the [Software Installation](#) section) from the flash disk or Dropbox link.
4. Turn ON the switch.
5. Wait until there is **Blue** light (the system is ready to use).
6. You may now open the GUI (**Green** light means serial data transfer active).
7. Connect XDAC output to your Device Under Test (DUT).

3. Software and Graphical User Interface (GUI)

Software Requirement

The GUI software is suitable for the following operating systems:

- Windows® 7 (32-bit, 62-bit).
- Windows® 10 (32-bit, 62-bit).
- Windows® 11 (64-bit).
- macOS Big Sur.
- Linux Ubuntu.

Software Installation

The first step is to install the XDAC_setup.exe file into your computer and then double-click to launch the GUI. The icon is as below:

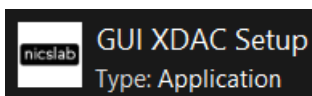

At the end step of the installation, check a 'Create a desktop shortcut'.

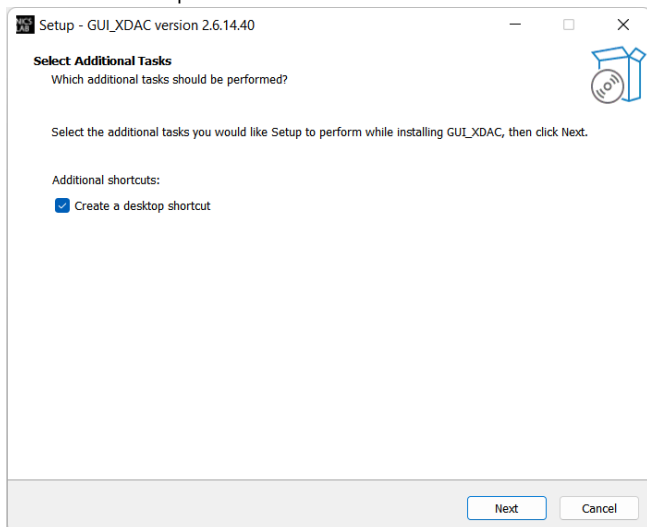

Double-click the executable GUI icon (as shown below) on your desktop to launch the GUI.

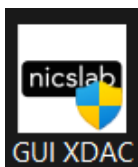

Graphical User Interface (GUI)

Start the XDAC by pressing the ON button, then you can control it by GUI. the display details are on the next page.

First, set up the connection to your instruments by entering the IP address. Please scan the XDAC IP address to know the XDAC IP. The XDAC IP address should appear if you scan it in the local network using an IP scanner such as Angry IP Scanner or NMAP.

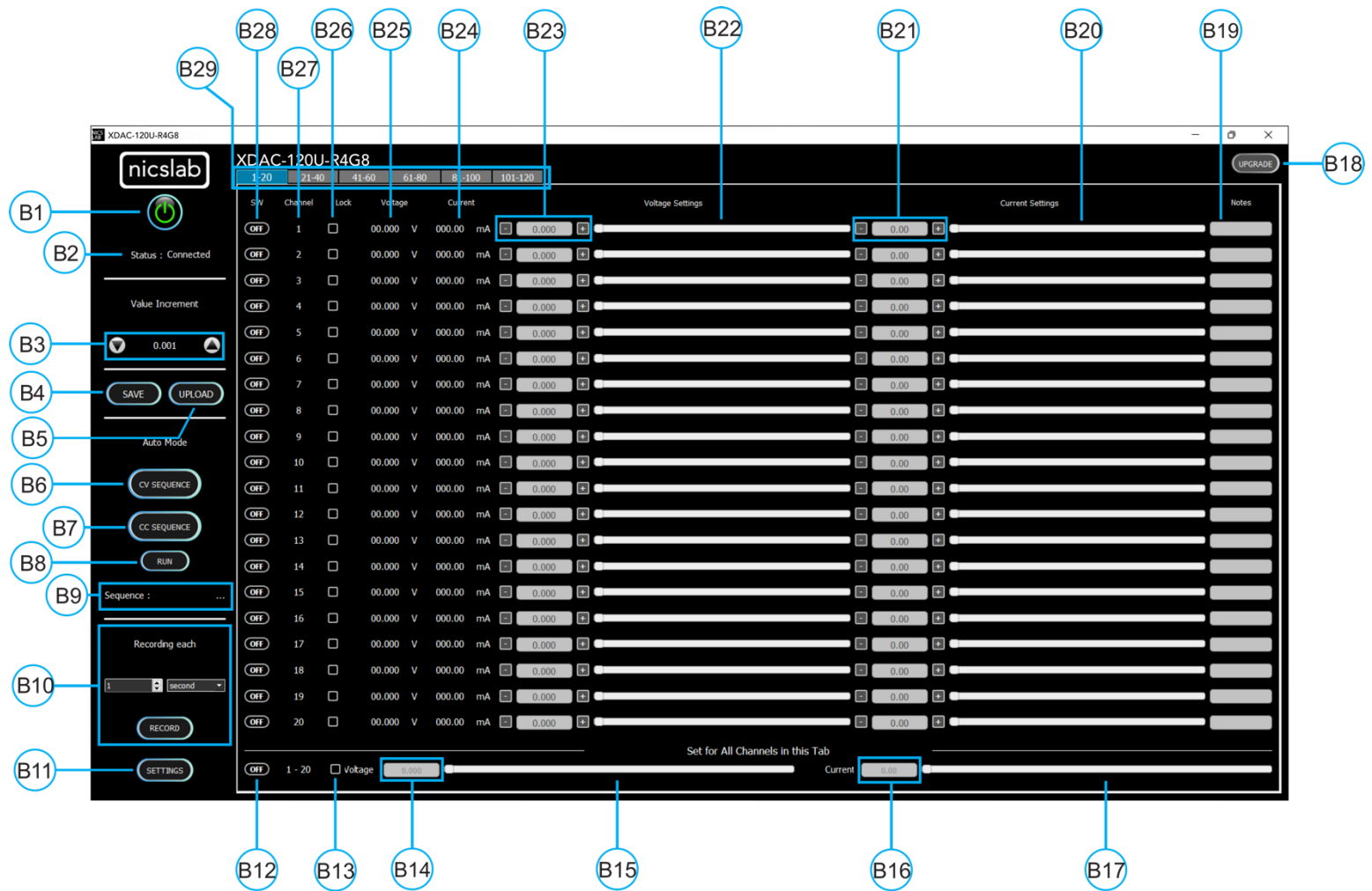

Figure 4. GUI

Note:

Callout	Description
B1	ON/OFF Switch
B2	Status of connection
B3	Increment Settings
B4	Save File Button - <i>Premium Feature</i>
B5	Upload File Button - <i>Premium Feature</i>
B6	Auto Feature Sequence: Upload Table Button I CV Mode - <i>Premium Feature</i>
B7	Auto Feature Sequence: Upload Table Button I CC Mode - <i>Premium Feature</i>
B8	Auto Feature: Run Button CV and/or CC Mode - <i>Premium Feature</i>
B9	Name of the Sequence - <i>Premium Feature</i>
B10	Record Data Button - <i>Premium Feature</i>
B11	Setting for: <ol style="list-style-type: none"> 1. Set Limit voltage and current values - <i>Premium Feature</i> 2. V Range (16-bit precision for every range of voltages: 5, 10, 20, 34 V) - <i>Premium Feature</i> 3. C Range (16-bit precision for every range of currents: 300, 200, 100, 50, 25, 12.5, 6.25 and 3.125mA) - <i>Premium Feature</i> – <i>Firmware version 4.1.1.1 and up.</i> 4. Set the Reading speed of Voltage and Current - <i>Premium Feature</i>
B12	ON/OFF Button for the current Tab
B13	Enable/Disable (Lock) Channel Controller for all channels in the current tab
B14	Text area to set the voltage for all channels in the current tab
B15	Slider to set the voltage for all channels in the current tab
B16	Text area to set the current for all channels in the current tab
B17	Slider to set current for all channels in the current tab
B18	Upgrade Button
B19	Notes - <i>Premium Feature</i>
B20	Current Settings Slider
B21	Current Value Based on Increment Setting
B22	Voltage Settings Slider
B23	Voltage Value Based on Increment Setting
B24	Current Value
B25	Voltage Value
B26	Enable/Disable (Lock) Channel Controller
B27	Number of channels
B28	ON/OFF Button per Channel
B29	Tab Channel

Initializing the GUI

This section shows how to initialize the GUI:

1. Launch the program by double-clicking the "XDAC_setup_exe" icon.
2. Enter XDAC's IP address and XDAC key as given. If the connection is successful, then the GUI will open and there is the Green indicator light.

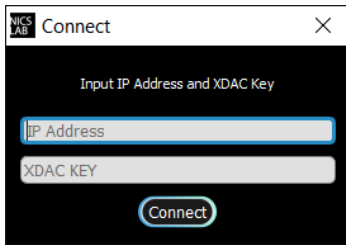

3. Press the 'ON/OFF' button (B1) to start the GUI.



4. Turn ON (B28) on each channel to the input voltage and current values.

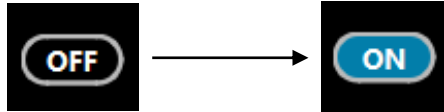

Premium Upgrade

This section shows how to upgrade the GUI to enable advanced features.

1. Press the upgrade button (B18) at the top right corner of the window

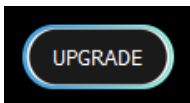

2. After the upgrade window opened, input the Premium Upgrade Key.

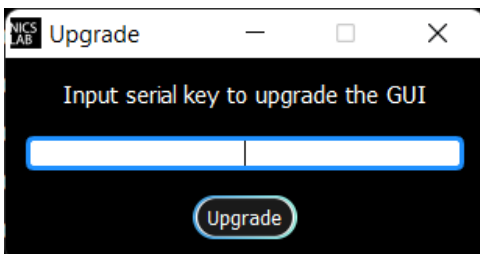

3. If your Premium Upgrade Key is valid, you will get a message that indicates a successful upgrade.

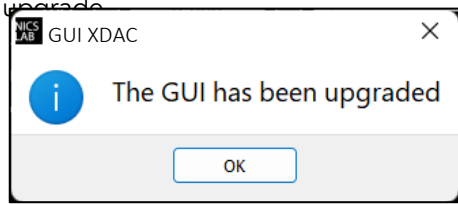

4. You can use several features that were previously locked.

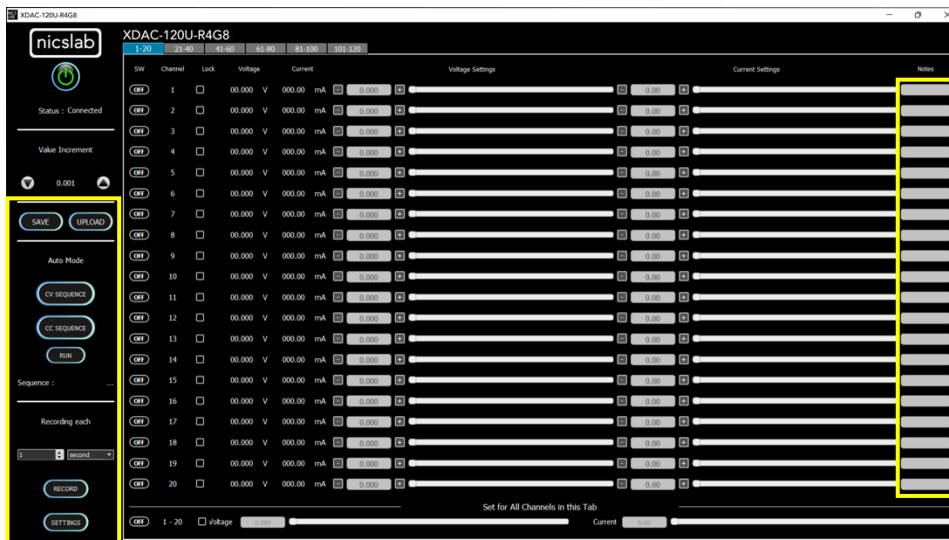
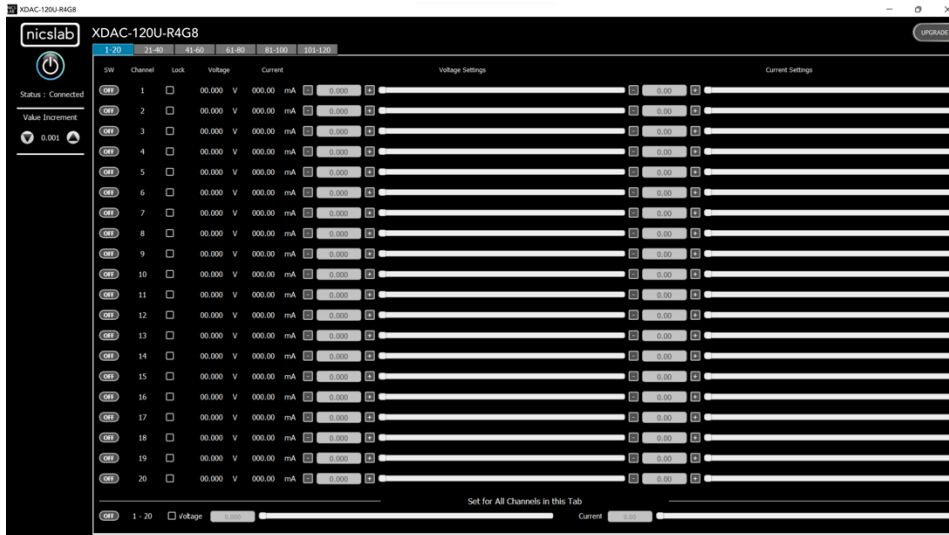

The next few sections are the advanced features that are enabled after upgrading the GUI.

Constant Current Mode (CC) Mode

This section shows how to do CC mode according to your purpose:

To do CC mode, you need to move the voltage slider (B22) or adjust the voltage value (B23) to a certain value before setting the current value on (B21) or slider (B20). As an example, channel 1 in the below picture was given a 100 Ω load.

Important note: When you manually input the values, always press 'Enter'.

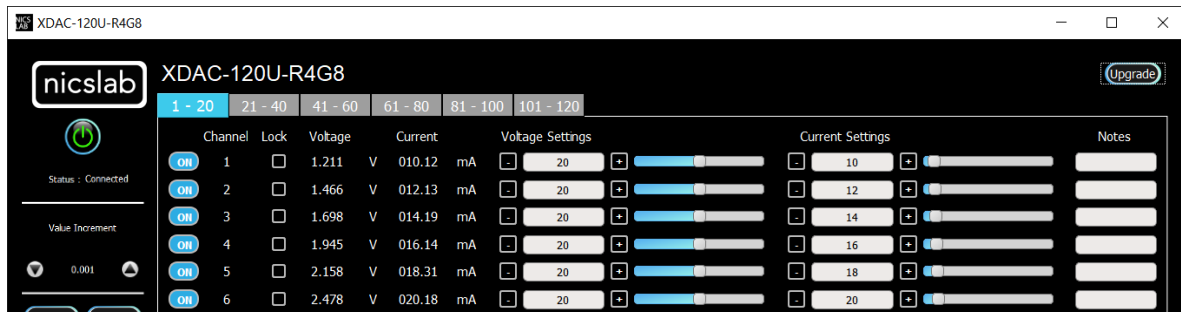

Constant Voltage Mode (CV) Mode

This section shows how to do CV mode according to your aim:

To do CV mode, you need to move the current slider (B20) or adjust the current value (B21) to a certain value. Then adjust the voltage value on (B23) or slider (B22).

Important note: When you manually input the values, always press 'Enter'.

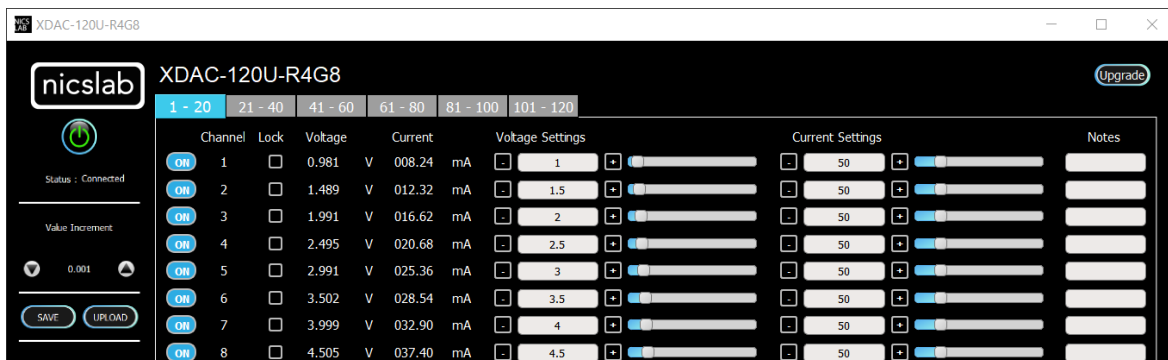

Value Increment Setting

In this setting, the value of the voltage and current can be incrementally changed from a minimum of 0.001 to 1. Adjust the arrow to increase and decrease the value increment (B3).

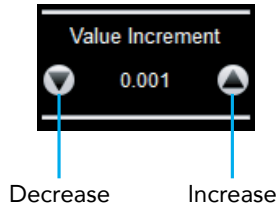

Save and Upload

The CSV file (.csv) resulting from the Save function can be uploaded again through the Upload button (B5). You may also create your own CSV file of voltage and current and upload it later.

1. To save the configuration, click the 'Save' button (B4).



2. Select a directory and write the file name.

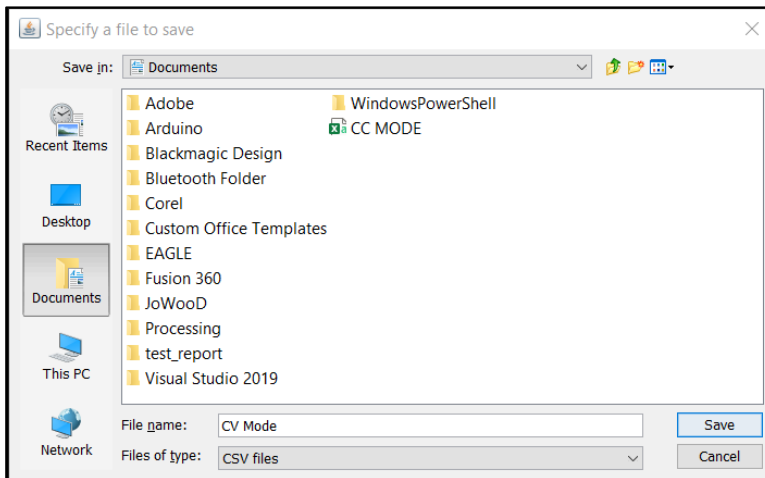

3. The file will be saved as a .csv file.
4. Check the .csv file that you have saved.

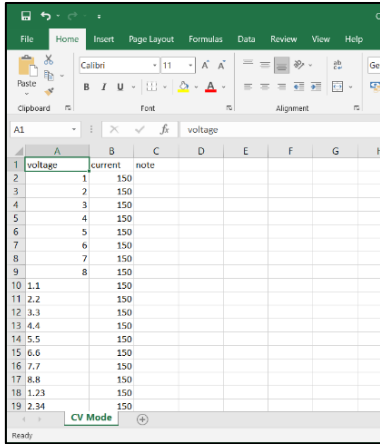

The voltage, current, and notes are recorded. If the file doesn't appear to have saved data from all channel, consider trying to open the file with another program, like Notepad, for further inspection.

- To upload the configuration, click the 'Upload' button (B5).



- Choose and open the intended file.

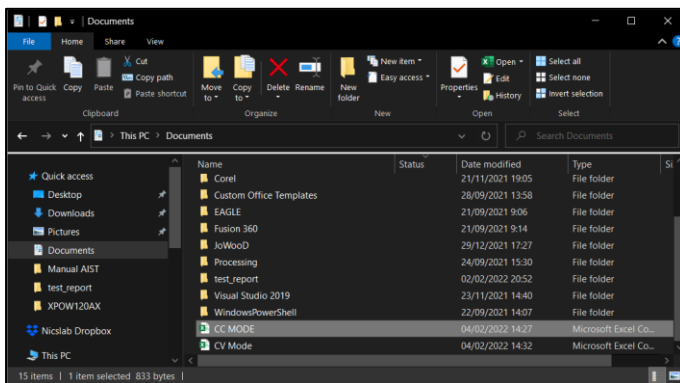

- It will upload the configuration like the previous configuration.

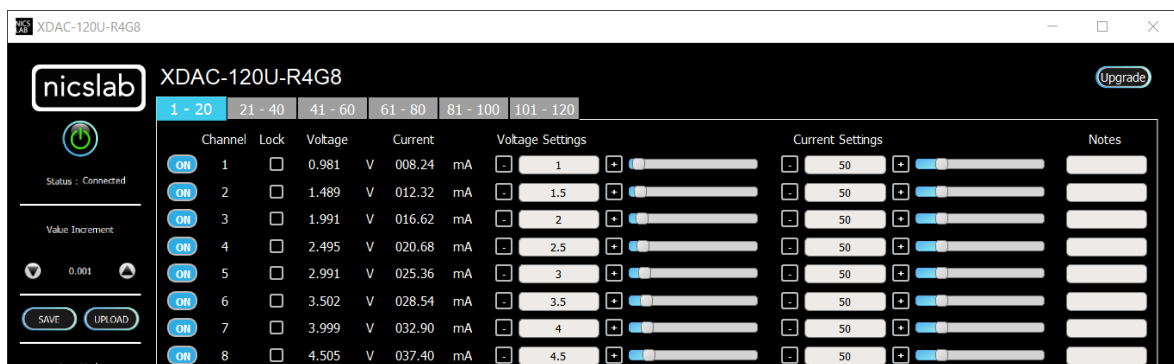

Note: When you upload CV mode, the current setting slider values automatically show 2184.50 bits to open the current flow from the supply. You may adjust this to match your requirements.

Sequence Automation

Sequence is the setting that automates the determined values of current (mA) or voltage (V) given the certain Delay Time (in milliseconds).

- The template of the sequence is given, then you need to input your intended values of CC Sequence (from 0 to 300 mA), CV Sequence (from 0 to 34 V), and Delay Time (in milliseconds). Set the delay time to more than 2 seconds to have more accurate values. To have a faster response (switching time) you can set it via the SCPI command (see Operating XDAC through the SCPI command).

	A	B	C	D	E	F	G	H	I	J
1		Seq 1	Seq 2	Seq 3	Seq 4	Seq 5	Seq 6	Seq 7	Seq 8	Note
2	Delay Time	6000	5478	4912	3409	4213	5902	6012		
3	Channel 1	5	50	0	100	150	150	0	300	Fan1
4	Channel 2	10	50	0	100	160	150	0	300	Fan2
5	Channel 3	15	50	0	100	170	150	0	300	Motor1
6	Channel 4	20	50	0	100	180	150	0	300	Motor2
7	Channel 5	25	50	0	100	190	150	0	300	Sensor1
8	Channel 6	30	50	0	100	200	150	0	300	Sensor2
9	Channel 7	35	50	0	100	210	150	0	300	Sensor3
10	Channel 8	40	50	0	100	220	150	0	300	Not Used

Note:

- Template given for CC and CV sequences.
 - Input your intended values according to the modes (CC: 0 – 300 mA, CV: 0 – 34 V).
- Choose the sequence mode that you will use, either CV Sequence (B6) or CC sequence (B7). When you click, for example, if you want to use a CC sequence, you need to open the corresponding CSV sequence file.
 - After uploading, choose sequence mode by clicking 'Run' (B8). It will run either CC, CV, or CC & CV Sequence depends on the .csv file that you uploaded before.

Important note: when 'Run CCCV' use the same delay time on the template .csv of CC and CV sequence.

Record

'Record' (B10) keeps data on voltage and current values. You can choose how often the data is stored in a unit of time. The default value is the data will be stored each one second. The record starts by the time you click the Record button and will finish when you click again the same button.

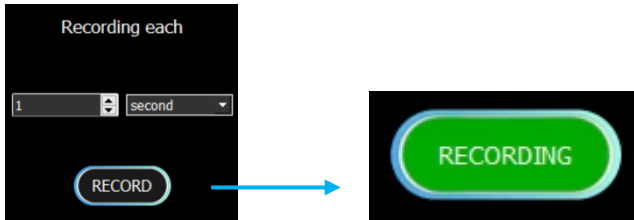

Click the same button to stop Recording. After that, put the file in any directory

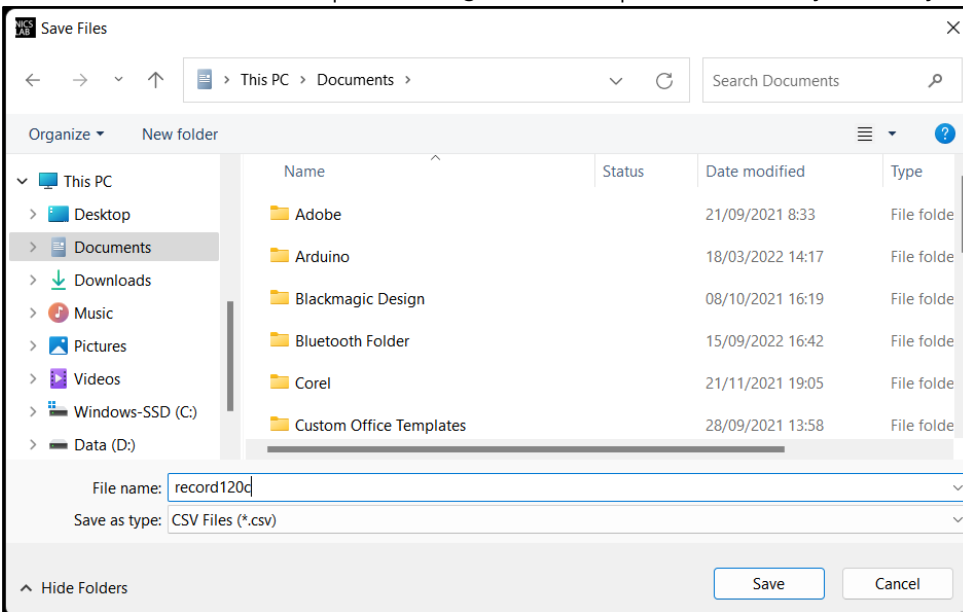

This is the output of the recorded file

Time Stamp	Voltage[1]	Current[1]	Notes	Voltage[2]	Current[2]	Notes	Voltage[3]	Current[3]	Notes	Voltage[4]	Current[4]	Notes	Voltage[5]	Current[5]	Notes	Voltage[6]	Current[6]	Notes
20:29:19	1.111 V	9.1 mA	Fan1	1.053 V	9.17 mA	Fan2	1.125 V	9.12 mA	Motor1	1.107 V	9.12 mA	Motor2	1.099 V	9.07 mA	Sensor1	1.112 V	9.05 n	
20:29:20	1.111 V	9.07 mA	Fan1	1.053 V	9.17 mA	Fan2	1.125 V	9.12 mA	Motor1	1.107 V	9.12 mA	Motor2	1.099 V	9.07 mA	Sensor1	1.112 V	9.05 n	
20:29:21	1.111 V	9.1 mA	Fan1	1.053 V	9.17 mA	Fan2	1.125 V	9.12 mA	Motor1	1.107 V	9.12 mA	Motor2	1.1 V	9.07 mA	Sensor1	1.112 V	9.05 n	
20:29:22	1.111 V	9.1 mA	Fan1	1.053 V	9.17 mA	Fan2	1.125 V	9.12 mA	Motor1	1.107 V	9.12 mA	Motor2	1.099 V	9.07 mA	Sensor1	1.112 V	9.05 n	
20:29:23	1.111 V	9.1 mA	Fan1	1.053 V	9.17 mA	Fan2	1.125 V	9.12 mA	Motor1	1.107 V	9.12 mA	Motor2	1.1 V	9.07 mA	Sensor1	1.112 V	9.05 n	
20:29:24	1.111 V	9.1 mA	Fan1	1.053 V	9.17 mA	Fan2	1.125 V	9.12 mA	Motor1	1.107 V	9.12 mA	Motor2	1.1 V	9.07 mA	Sensor1	1.112 V	9.05 n	
20:29:25	8.716 V	71.8 mA	Fan1	1.054 V	9.17 mA	Fan2	1.125 V	9.12 mA	Motor1	1.107 V	9.12 mA	Motor2	1.1 V	9.07 mA	Sensor1	1.112 V	9.05 n	
20:29:26	8.716 V	71.8 mA	Fan1	1.054 V	9.17 mA	Fan2	1.125 V	9.12 mA	Motor1	1.107 V	9.12 mA	Motor2	1.1 V	9.07 mA	Sensor1	1.112 V	9.05 n	
20:29:27	8.716 V	71.8 mA	Fan1	1.054 V	9.17 mA	Fan2	1.125 V	9.12 mA	Motor1	1.107 V	9.12 mA	Motor2	1.1 V	9.07 mA	Sensor1	1.112 V	9.05 n	
20:29:28	8.716 V	71.8 mA	Fan1	8.699 V	76.37 mA	Fan2	1.125 V	9.12 mA	Motor1	1.109 V	9.15 mA	Motor2	1.1 V	9.07 mA	Sensor1	1.112 V	9.05 n	
20:29:29	8.717 V	71.8 mA	Fan1	8.699 V	76.35 mA	Fan2	1.125 V	9.12 mA	Motor1	1.109 V	9.15 mA	Motor2	1.1 V	9.07 mA	Sensor1	1.112 V	9.05 n	
20:29:30	8.717 V	71.8 mA	Fan1	8.699 V	76.35 mA	Fan2	1.125 V	9.12 mA	Motor1	1.109 V	9.15 mA	Motor2	1.1 V	9.07 mA	Sensor1	1.112 V	9.05 n	
20:29:31	8.717 V	71.8 mA	Fan1	8.699 V	76.35 mA	Fan2	1.156 V	9.35 mA	Motor1	1.109 V	9.12 mA	Motor2	1.1 V	9.07 mA	Sensor1	1.112 V	9.05 n	
20:29:32	8.717 V	71.8 mA	Fan1	8.699 V	76.35 mA	Fan2	1.372 V	11.15 mA	Motor1	1.109 V	9.15 mA	Motor2	1.1 V	9.07 mA	Sensor1	1.112 V	9.05 n	
20:29:33	8.717 V	71.8 mA	Fan1	8.699 V	76.35 mA	Fan2	1.372 V	11.15 mA	Motor1	1.475 V	12.2 mA	Motor2	1.1 V	9.07 mA	Sensor1	1.114 V	9.05 n	
20:29:34	8.716 V	71.8 mA	Fan1	8.699 V	76.35 mA	Fan2	1.372 V	11.15 mA	Motor1	1.474 V	12.2 mA	Motor2	1.1 V	9.07 mA	Sensor1	1.112 V	9.05 n	
20:29:35	8.717 V	71.8 mA	Fan1	8.699 V	76.35 mA	Fan2	1.372 V	11.15 mA	Motor1	1.475 V	12.2 mA	Motor2	2.148 V	17.75 mA	Sensor1	1.114 V	9.05 n	
20:29:36	8.716 V	71.77 mA	Fan1	8.699 V	76.35 mA	Fan2	1.372 V	11.15 mA	Motor1	1.475 V	12.2 mA	Motor2	2.441 V	20.22 mA	Sensor1	1.72 V	13.82	
20:29:37	8.716 V	71.77 mA	Fan1	8.699 V	76.35 mA	Fan2	1.372 V	11.15 mA	Motor1	1.475 V	12.2 mA	Motor2	2.441 V	20.22 mA	Sensor1	3.7 V	30.27	
20:29:38	8.716 V	71.77 mA	Fan1	8.699 V	76.35 mA	Fan2	1.372 V	11.15 mA	Motor1	1.475 V	12.2 mA	Motor2	2.441 V	20.22 mA	Sensor1	3.7 V	30.27	

Settings

Click the 'Settings' button (B11).



The 'Settings' feature consists of:

- Setting the maximum limit for both current and/or voltage values

Set Voltage Limit

SW	Channel	Lock	Voltage	Current	Voltage Settings	Current Settings	Notes
ON	1	<input type="checkbox"/>	00.00 V	00.00 mA	0	20	
ON	2	<input type="checkbox"/>	00.00 V	00.00 mA	0	20	
ON	3	<input type="checkbox"/>	00.00 V	00.00 mA	0	20	
ON	4	<input type="checkbox"/>	00.00 V	00.00 mA	0	20	
ON	5	<input type="checkbox"/>	00.00 V	00.00 mA	0	20	
ON	6	<input type="checkbox"/>	00.00 V	00.00 mA	0	20	
ON	7	<input type="checkbox"/>	00.00 V	00.00 mA	0	20	
ON	8	<input type="checkbox"/>	00.00 V	00.00 mA	0	20	
ON	9	<input type="checkbox"/>	00.00 V	00.00 mA	0	20	
ON	10	<input type="checkbox"/>	00.00 V	00.00 mA	0	20	
ON	11	<input type="checkbox"/>	00.00 V	00.00 mA	0	20	
ON	12	<input type="checkbox"/>	00.00 V	00.00 mA	0	20	
ON	13	<input type="checkbox"/>	00.00 V	00.00 mA	0	20	
ON	14	<input type="checkbox"/>	00.00 V	00.00 mA	0	20	
ON	15	<input type="checkbox"/>	00.00 V	00.00 mA	0	20	
ON	16	<input type="checkbox"/>	00.00 V	00.00 mA	0	20	
ON	17	<input type="checkbox"/>	00.00 V	00.00 mA	0	20	
ON	18	<input type="checkbox"/>	00.00 V	00.00 mA	0	20	
ON	19	<input type="checkbox"/>	00.00 V	00.00 mA	0	20	
ON	20	<input type="checkbox"/>	00.00 V	00.00 mA	0	20	

Set Current Limit

SW	Channel	Lock	Voltage	Current	Voltage Settings	Current Settings	Notes
ON	1	<input type="checkbox"/>	00.00 V	00.00 mA	0	20	
ON	2	<input type="checkbox"/>	00.00 V	00.00 mA	0	20	
ON	3	<input type="checkbox"/>	00.00 V	00.00 mA	0	20	
ON	4	<input type="checkbox"/>	00.00 V	00.00 mA	0	20	
ON	5	<input type="checkbox"/>	00.00 V	00.00 mA	0	20	
ON	6	<input type="checkbox"/>	00.00 V	00.00 mA	0	20	
ON	7	<input type="checkbox"/>	00.00 V	00.00 mA	0	20	
ON	8	<input type="checkbox"/>	00.00 V	00.00 mA	0	20	
ON	9	<input type="checkbox"/>	00.00 V	00.00 mA	0	20	
ON	10	<input type="checkbox"/>	00.00 V	00.00 mA	0	20	
ON	11	<input type="checkbox"/>	00.00 V	00.00 mA	0	20	
ON	12	<input type="checkbox"/>	00.00 V	00.00 mA	0	20	
ON	13	<input type="checkbox"/>	00.00 V	00.00 mA	0	20	
ON	14	<input type="checkbox"/>	00.00 V	00.00 mA	0	20	
ON	15	<input type="checkbox"/>	00.00 V	00.00 mA	0	20	
ON	16	<input type="checkbox"/>	00.00 V	00.00 mA	0	20	
ON	17	<input type="checkbox"/>	00.00 V	00.00 mA	0	20	
ON	18	<input type="checkbox"/>	00.00 V	00.00 mA	0	20	
ON	19	<input type="checkbox"/>	00.00 V	00.00 mA	0	20	
ON	20	<input type="checkbox"/>	00.00 V	00.00 mA	0	20	

Important note: When you input the values, always press 'Enter'.

- Setting range for voltage (B22, B23, and B25) and current (B20, B21, and B24). The range of voltages are 0 – 5 V, 0 – 10 V, 0 – 20 V, and 0 – 34 V. The range of currents are 0 – 300 mA, 0 – 200 mA, 0 – 100 mA, 0 – 50 mA, 0 – 25 mA, 0 – 12.5 mA, 0 – 6.25 mA and 0 – 3.125 mA. Each range has 16-bit precision. The set range setting is also restricting the set limit setting, so the limit cannot exceed the range.

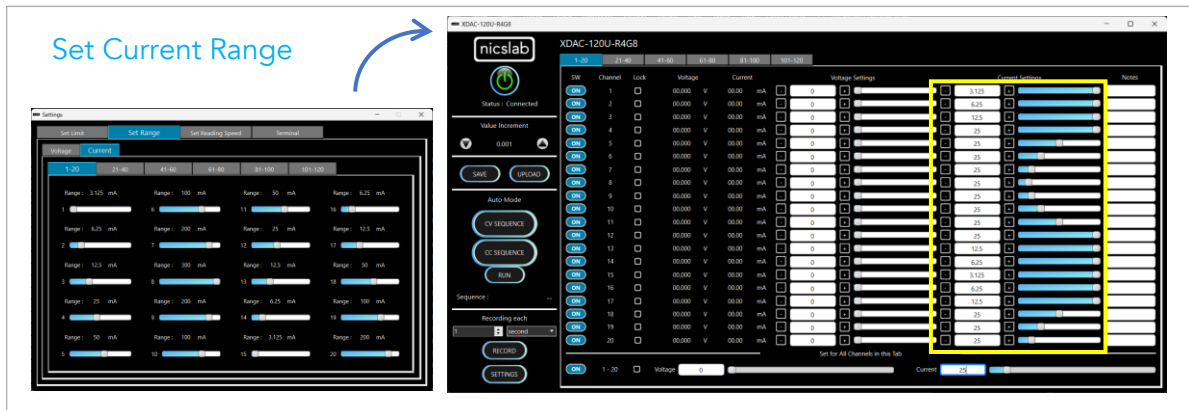
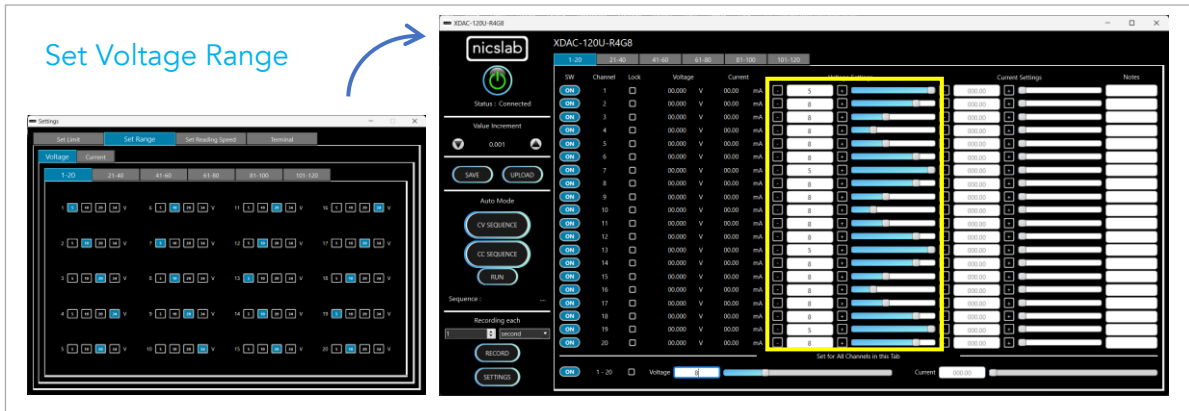

Important note: Current range configuration only available on Firmware version 4.1.1.1 and up

- Setting the reading speed to adjust different speed for reading voltage and current. The speed is based on averaging number of sample output values. Faster options can make conversion time smaller but the results noisier. The latest firmware has more degree of flexibility regarding reading speed value.

Reading Speed



Reading Speed (Latest Firmware)

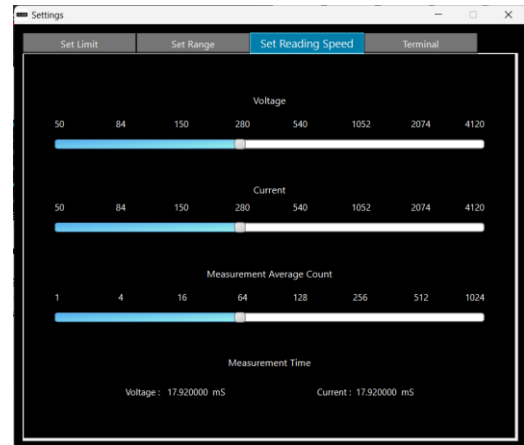

- Set threshold for voltage and current measurement value (B24 & B25). The range is similar to set limit which is 0 – 34 for voltage and 0 – 300 for current. User can set the upper and lower bound value. User can turn on or off this feature at will by toggling the checkbox beside each channel number. If the measured value reached or exceeds the threshold value, the hardware will adjust the value and a warning sign will appear in the setting window. After the threshold is triggered and the channel is turned off, you need to re-enable the threshold feature and re-enter the control value for the channel that turned off. This feature is useful for voltage or current sensitive equipment that cannot exceed a certain value.

Set Threshold (OFF)



Set Threshold (ON and Triggered)



Measured Value at > 10 V

In the mainwindow, each channel that have threshold feature triggered is also turned green:

XDAC-120U-R4G8

SW	Channel	Lock	Voltage	Current	Voltage Settings		Current Settings		Notes
ON	1 open	<input type="checkbox"/>	10.087 V	004.96 mA	- 10	+ [Slider]	- 5	+ [Slider]	
ON	2 open	<input type="checkbox"/>	10.057 V	005.04 mA	- 10	+ [Slider]	- 5	+ [Slider]	
ON	3 open	<input type="checkbox"/>	10.052 V	004.95 mA	- 10	+ [Slider]	- 5	+ [Slider]	
ON	4 open	<input type="checkbox"/>	10.049 V	004.95 mA	- 10	+ [Slider]	- 5	+ [Slider]	
ON	5 open	<input type="checkbox"/>	09.965 V	004.96 mA	- 10	+ [Slider]	- 5	+ [Slider]	
OFF	6	<input type="checkbox"/>	00.000 V	000.00 mA	-	+ [Slider]	-	+ [Slider]	
OFF	7	<input type="checkbox"/>	00.000 V	000.00 mA	-	+ [Slider]	-	+ [Slider]	
OFF	8	<input type="checkbox"/>	00.000 V	000.00 mA	-	+ [Slider]	-	+ [Slider]	
OFF	9	<input type="checkbox"/>	00.000 V	000.00 mA	-	+ [Slider]	-	+ [Slider]	
OFF	10	<input type="checkbox"/>	00.000 V	000.00 mA	-	+ [Slider]	-	+ [Slider]	

Important note: Voltage and Current threshold configuration only available on Firmware version 4.1.1.1 and up

- Set shorted for voltage and current measurement value (B24 & B25). The trigger condition is when voltage value on a channel is between -0.03 to 0.03 and the current value is between -5 to 5. User can turn on or off this feature at will by toggling the checkbox beside each channel number. If the measured value is inside the range of shorted value, a warning sign will appear in the setting window. After the shorted is triggered and the channel is turned off, you need to re-enable the shorted feature and re-enter the control value for the channel that turned off. This feature is useful for voltage or current sensitive equipment that cannot last long in a shorted situation.

Set Shorted (OFF)



Set Shorted (ON and Triggered)



Measured Value at 0 V and 7.5 mA

In the mainwindow, each channel that have shorted feature triggered is also turned red:

XDAC-120U-R4G8											
1-20											
SW	Channel	Lock	Voltage	Current	Voltage Settings			Current Settings		Notes	
ON	1 shorted	<input type="checkbox"/>	00.000 V	007.47 mA	-	0	+	-	7.5	+	
ON	2 shorted	<input type="checkbox"/>	00.000 V	007.45 mA	-	0	+	-	7.5	+	
ON	3 shorted	<input type="checkbox"/>	00.000 V	007.51 mA	-	0	+	-	7.5	+	
ON	4 shorted	<input type="checkbox"/>	00.000 V	007.44 mA	-	0	+	-	7.5	+	
ON	5 shorted	<input type="checkbox"/>	00.000 V	007.49 mA	-	0	+	-	7.5	+	
OFF	6	<input type="checkbox"/>	00.000 V	000.00 mA	-		+	-		+	
OFF	7	<input type="checkbox"/>	00.000 V	000.00 mA	-		+	-		+	
OFF	8	<input type="checkbox"/>	00.000 V	000.00 mA	-		+	-		+	
OFF	9	<input type="checkbox"/>	00.000 V	000.00 mA	-		+	-		+	
OFF	10	<input type="checkbox"/>	00.000 V	000.00 mA	-		+	-		+	

Important note: Voltage and Current shorted configuration only available on Firmware version 4.1.1.1 and up

- Devices to connect additional devices that can be controlled using one GUI. This feature is useful when you have multiple XDACs and need to connect them using one GUI. You can also disconnect or shutdown a particular device. **This feature is an optional addition to your XDAC, so contact our team beforehand.**

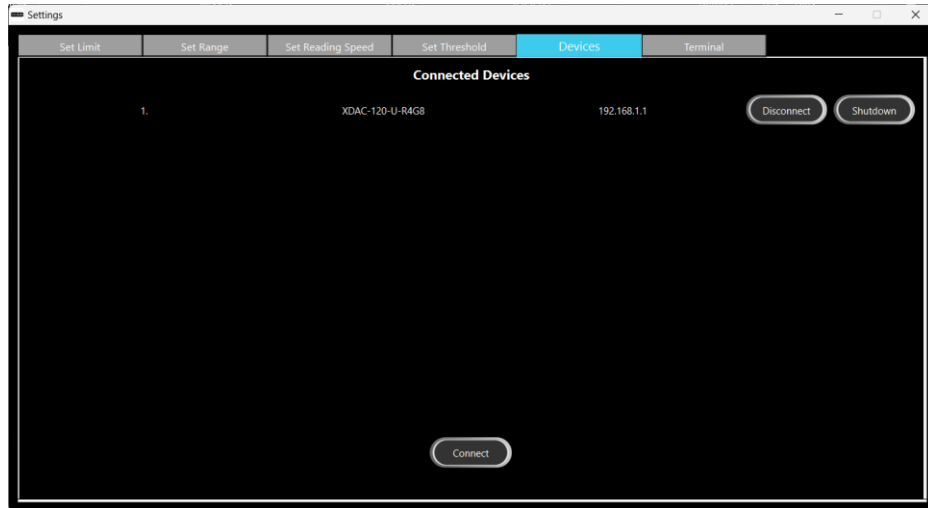

- Terminal to read the input from software to hardware and the corresponding hardware response. This feature is useful to find problems with the hardware or software.

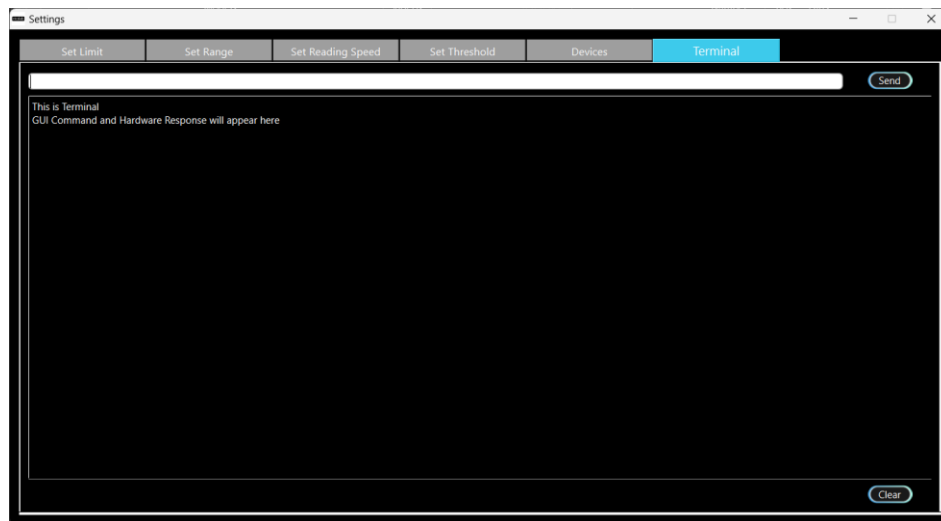

4. Operating XDAC through the SCPI command

This section set guidelines to help you develop a program for any language that suits you best. As an example, we give the Python example.

Python Installation (Example)

Please follow the steps below for dynamic programming using the SCPI command through Python via TCP/IP.

The following Python version and package need to be installed:

1. Python 2.7 or Python 3.X (download and install the latest version from www.python.org). *Tested with Python 3.9.
2. PyCharm 2017.3.4 or the latest version (download and install the latest version from <https://www.jetbrains.com/pycharm/>)

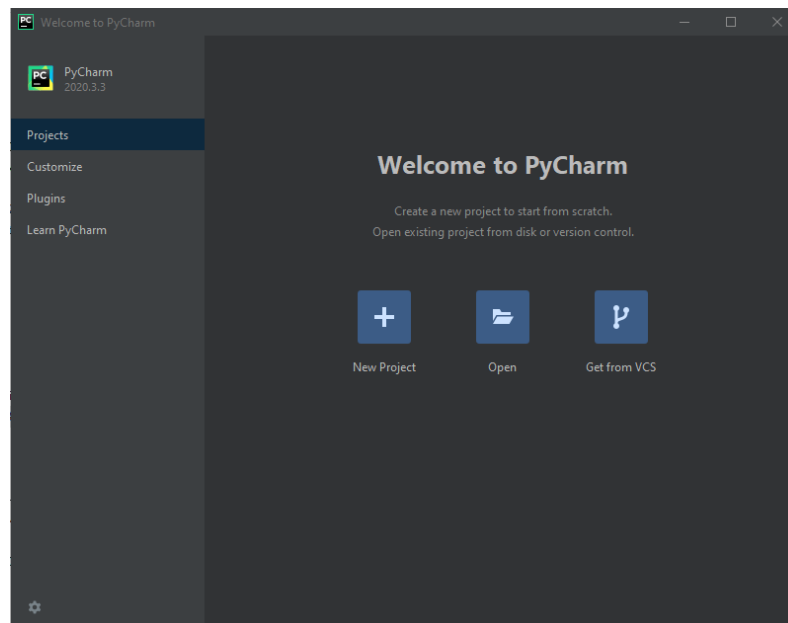

Run Python Code (Example)

To run the Python code please follow the steps below:

1. Open PyCharm software and open file example (e.g XDAC-120U-R4G8-SMA.py)

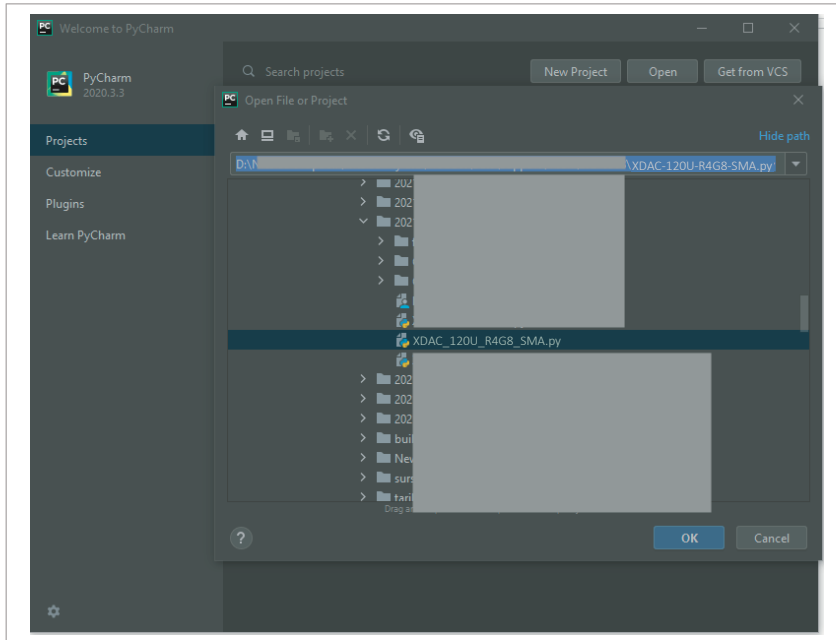

2. Configure the Python interpreter (see figure below) by clicking Configure Python Interpreter link on the drop-down menu, or in File >> Settings >> Project Interpreter.

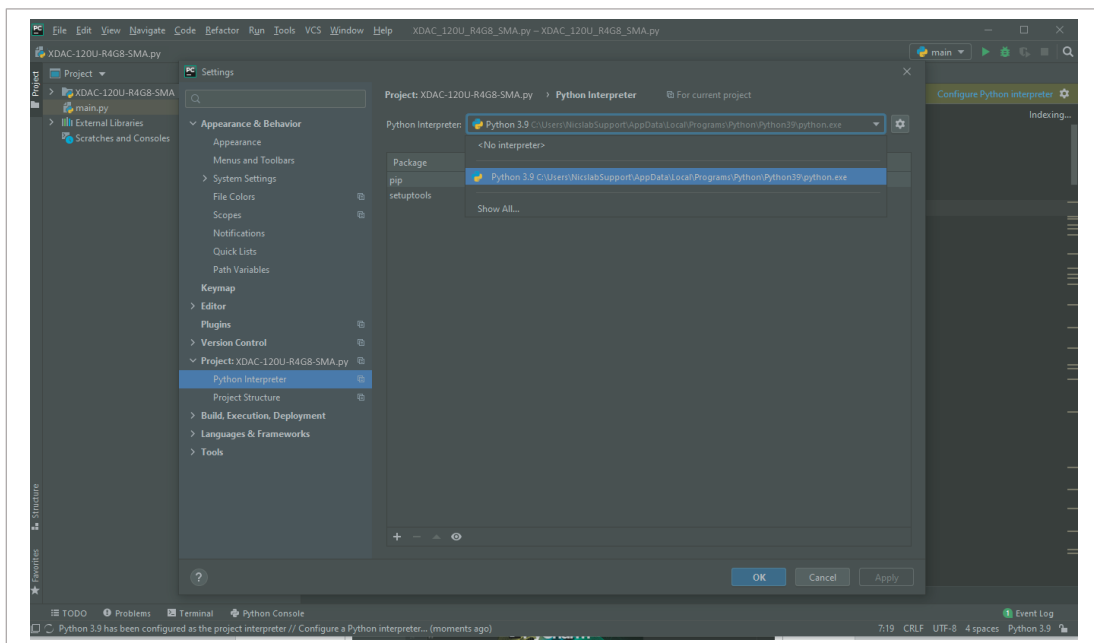

3. Install additional packages, for example, enum34, by:
 - A. clicking '+' button
 - B. searching and choosing enum34
 - C. installing all the packages.

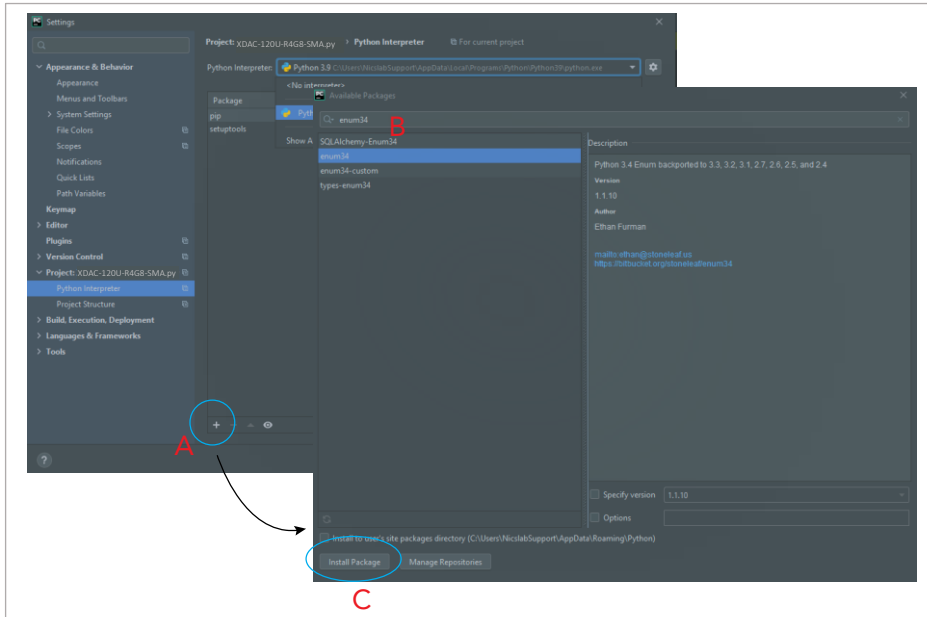

4. The packages for the Python Interpreter are listed in the green rectangle.

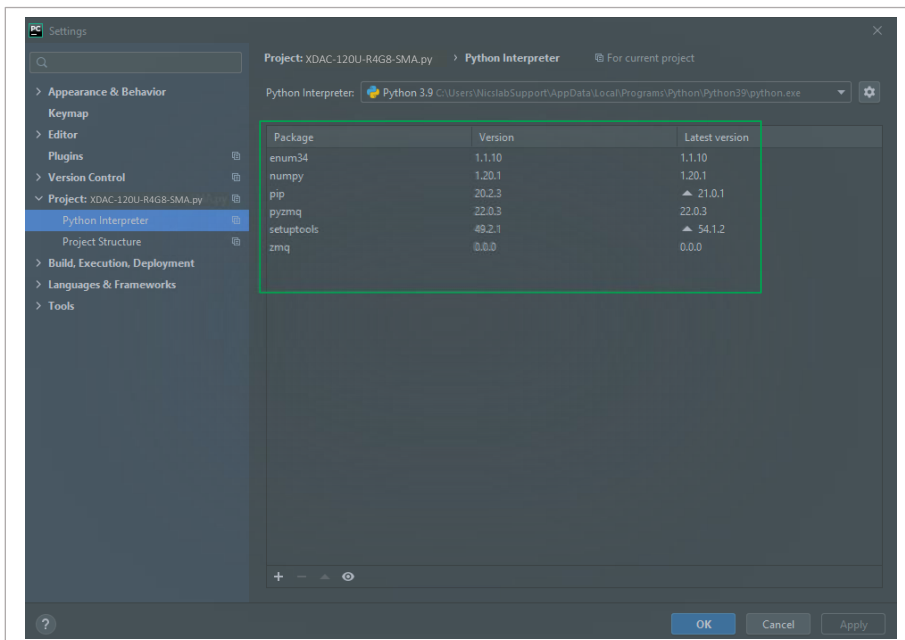

5. Select Python Configuration and choose the file name.
6. Run the file by clicking the green arrow button on the top right corner to test the XDAC (Please refer to the code and SCPI commands references).

Python Function (Example)

1. Input IP Address

```
XDAC_IP = "169.xxx.xx.xx"
```

2. Unlock and Lock XDAC

```
unlock(XDACkey)
```

```
lock()
```

note: You must unlock your XDAC first before you can use it.

3. Set XDAC voltage range for all channels and measurement mode

```
setXDAC(voltRange, voltReadingMode, currentReadingMode )
```

voltRange (int list): list for all channels range

voltReadingMode (string): "FAST" or "MEDIUM" or "SLOW"

currentReadingMode (string): "FAST" or "MEDIUM" or "SLOW"

Example:

```
AllRValues = [5, 5, 6, 7, 5, 5, 7, 4]
```

```
setXDAC(AllRValues, "FAST", "SLOW")
```

4. Set Voltage for single channel

```
setChannelVoltage(channel, voltageVal)
```

channel (int): channel number

voltageVal (float): 0 - 34 V

Example:

```
setChannelVoltage(1, 15)
```

```
#Set voltage to 15 V in channel 1
```

5. Set Current for single channel

```
setChannelCurrent(channel, currentVal)
```

channel (int): channel number

currentVal (float): 0 - 300 mA

Example:

```
setChannelCurrent(1, 200)
```

#Set current to 200 mA in channel 1

6. Set Voltage Threshold for single channel

```
setChannelVoltageThreshold(channel, voltageVal)
```

channel (int): channel number

voltageVal (float): 0 - 34 V

Example:

```
setChannelVoltageThreshold(1, 25)
```

#Set voltage threshold to 25 V in channel 1

7. Set Current Threshold for single channel

```
setChannelCurrentThreshold(channel, currentVal)
```

channel (int): channel number

currentVal (float): 0 - 300 mA

Example:

```
setChannelCurrentThreshold(2, 250)
```

#Set current threshold to 250 mA in channel 2

8. Set Voltage Range for single channel

```
setChannelVoltageRange(channel, range)
```

channel (int): channel number

rangeVal (int): 0 - 3

0 = 0 - 5 V

1 = 0 - 10 V

2 = 0 - 20 V

3 = 0 - 34 V

9. Set for all channels

setVoltageAllChannels (AllVValues)

AllVValues (float array): voltage values in an array (V)

setCurrentAllChannels (AllCValues)

AllCValues (float array): current values in array (mA)

setRangeAllChannels (AllRValues)

AllRValues (float array): range values in an array

Example:

AllCValues = [100, 150, 100, 50, 200, 10, 10]

AllVValues = [20.1, 2.5, 13.0, 4, 5, 10.5, 9.5, 22]

AllRValues = [5, 5, 6, 7, 5, 5, 7, 4]

setRangeAllChannels (AllRValues)

setVoltageAllChannels (AllVValues)

setCurrentAllChannels (AllCValues)

10. Set OFF for single channel

setOff (channel)

channel (int): channel number

11. Read single-channel value

readSingleChannelVoltage (channel)

readSingleChannelCurrent (channel)

channel (int): channel number

return value of voltage or current in one channel

12. Read real-time value for all channels

readAllChannelVoltage ()

Return list of voltage from all channels

readAllChannelCurrent ()

Return list of current from all channels

13. Set one channel to run automatically and record it

```
sweepOne(channel, seqValueV, seqValueC, duration)
```

channel (int): channel number

seqValueV: voltage values in an array (V)

seqValueC: current values in an array (mA)

duration (int): duration in seconds

14. Measurement Configuration

```
measurementConfig(averagingSample, voltageConv, currentConv)
```

Set measurement averaging sample, voltage, and current conversion time

averagingSample (int): Measurement sample to be averaged

voltageConv (int μ S) = voltage conversion time in μ s

currentConv (int μ S) = current conversion time in μ s

15. Sweep value for single channel

```
sweepOne(channel, seqValueV, seqValueC, duration)
```

channel (int): channel number

seqValueV (list): list of voltage value

seqValueC (list): list of current value

duration (int): duration in seconds

16. Shutdown XDAC

```
shutdown()
```

SCPI Commands

The XDAC can be controlled using Standard Commands for Programmable Instruments (SCPI). To initialize the SCPI commands, you need to import ZMQ library. Then you must use Req-Rep mode in port "5555". After that you can type your commands and send it to the XDAC. You can see the example below:

```
import zmq

# Change with XDAC IP Address
XDAC_IP = "192.168. [REDACTED]"

# Connect to Req Server on XDAC via ZMQ
context = zmq.Context()
req_socket = context.socket(zmq.REQ)
req_socket.connect("tcp://%s:5555" % XDAC_IP)
```

Description: Unlock XDAC by XDAC Key

Format:

GETINFO:KEY

Example 1: Unlock XDAC with XDAC Key : nicslabtes.

GETINFO:nicslabtes

Description: Lock XDAC

Format:

LOCK

Description: Set output voltage for single channel

Format:

SETV:CHANNEL:VOLT

Example 1: Set the output of channel 1 to 4 V.

SETV:1:4

Example 2: Set the output of channel 3 to 0.25 V.

SETV:3:0.25

Description: Set output current for single channel

Format:

SETC:CHANNEL:CURRENT

Example 1: Set the output of channel 1 to 100 mA.

SETC:1:100

Example 2: Set the output of channel 3 to 50 mA.

SETC:3:50

Description: Set voltage threshold for single channel

Format:

SETOVT:CHANNEL:VOLT

Example 1: Set the output voltage threshold of channel 1 to 25 V.

SETOVT:1:25

Example 2: Set the output voltage threshold of channel 8 to 18 V.

SETOVT:8:18

Description: Set current threshold for single channel

Format:

SETOCT:CHANNEL:CURRENT

Example 1: Set the output current threshold of channel 1 to 250 mA.

SETOCT:1:250

Example 2: Set the output current threshold of channel 6 to 140 mA.

SETOCT:6:140

Description: Set output voltage range for single channel

Format:

SETR:CHANNEL:RANGE

range(int): 0 - 3

0 = 0 – 5 V

1 = 0 – 10V

2 = 0 – 20 V

3 = 0 – 34 V

Example 1: Set the output range of channel 1 to 0 – 34 V.

SETR:1:3

Description: Read voltage of a single channel

Format:

MEASV:CHANNEL

Example 1: Get the voltage output of channel 1.

MEASV:1

Description: Read current of a single channel

Format:

MEASC:CHANNEL

Example 1: Get the current output of channel 3.

MEASC:3

Description: Change Measurement config for All Channels

Format:

CONFIG:AVERAGINGSAMPLE:VOLTAGECONV:CURRENTCONV

Example: Set measurement configuration to 16 samples, 588 μ s voltage conversion time, and 588 μ s current conversion time.

CONFIG:16:588:588

Description: Set zero voltage for a single channel

Format:

ZERO:CHANNEL

example: Set zero of channel 1

ZERO:1

Description: Shutdown System

Format:

EXIT

5. System Shutdown

This section describes how to shut down the XDAC-120U-R4G8.

In the case of using GUI, the steps are as follows:

1. Set OFF all the channels in the GUI.
2. Press the ON/OFF Button in GUI (B1, Figure 4), this will change the color of the button from green to grey.
3. Close The GUI window (this will soft shut down the program inside the XDAC-120U-R4G8).
4. Press button A1 (Figure 3).
5. Turn off or disconnect the power from the DC Power Supply.

In the case of using SCPI or Python, the steps are as follows:

1. Use `setOff(channel)` function to set off the channel used before.
2. Use `lock()` and `shutdown()` functions to soft shut down the program inside the XDAC-120U-R4G8.
3. Press button A1 (Figure 3).
4. Turn off or disconnect the power from the DC Power Supply.

NOTE: once the soft shutdown occurred, the **Green & Blue** led will be turned off, and XDAC-120U-R4G8 cannot directly be used again, since the system is not ready (refers to Hardware Installation). To use XDAC-120U-R4G8 after a soft shutdown occurred, restart the power from DC Power Supply (using button A1 or unplug and plug the DC Power Supply).

6. Troubleshooting

Please use the following guidelines to identify the problem. If the solution does not rectify the problem, contact us at support@nicslab.com.

Table 7. Troubleshooting

Problem	Cause	Solution
Failed to connect at GUI	The DC power supply is OFF	Turn ON the DC power supply and switch ON the power.
Failed to connect at GUI	The power switch is OFF	Switch ON the power.
Failed to connect at GUI	No Green light (no data transfer)	Restart the GUI.
The Green light is off when the software is active or the software freezes	Initialization failed	Restart the software; or Unplug - plug the USB/Ethernet connector; or Press the Reset button.
No channel output detected at the device under test	Connection failed	Check the metal pad checkpoint to the intended channel.
Unable to upload the file	File format problem	Make sure the file format is .csv.
No value after uploading the file	File problem	Check the file content and make sure there is no blank space on each row.
Unable to use the Auto Mode feature	File format problem	Check the file format, it should be a .csv file. Check content format.

7. Warranty

Nicslab warrants the hardware and software designed by Nicslab to work accordingly fulfilling the highest standard of a quality product. Nicslab is not liable for consequential or incidental damages or errors in subject to misuse, neglect, accident, modification, or has been soldered or altered in any way outside stated by us or unauthorized maintenance.

Nicslab retains to change the material and technical data of this manual at any time without notice, in future editions.

Please do not hesitate to contact us at support@nicslab.com if you would like to have more information on the warranty or return and refund policy.

8. Compliance

This product complies with the requirements of the European Union's *Conformite Europeenne* (CE) and Restriction of Hazardous Substances in Electrical and Electronic Equipment (RoHS) Directive 2015/863 (RoHS3). The certificates can be accessed [here](#).

9. Contact

United States

Nicslab Ops, Inc.

228 Hamilton Avenue, 3rd Floor, Palo Alto

Silicon Valley, CA, 94301

Phone: +1 (650) 521-9982

Email: support@nicslab.com

Website: www.nicslab.com

Indonesia

PT. Nicslab Global Industri

Wisma Monex 9th floor

Jl. Asia Afrika No. 133-132, Bandung West Java 40112

Phone: +62 22 8602 6854

Email: nicslab.id@nicslab.com

Book a meeting [here](#).