

Ordering Information:



800 Village Walk #316
Guilford, CT 06437
Ph: 203-401-8093

Email orders to: sales@xsoptix.com
Fax orders to: 800-878-7282

XDAC-8MUB-R4G8

SPECIFICATION SHEET & MANUAL

2024

nicslab

CE RoHS

Version: 11.3

Date: 12 June 2024

Important Notice and Disclaimer:

No part of this document may be reproduced in any form or by any means (including electronic storage and retrieval or translation into a foreign language) without prior agreement and written consent from Nicslab. No responsibility is assumed by Nicslab for its use, nor for any infringements of patents or other rights of third parties that may result from its use. Trademarks and registered trademarks are the property of their respective owners.

This product is designated for skilled users. You are entirely responsible for (1) choosing the appropriate Nicslab products for your operation; (2) designing, validating, and testing your operation; and (3) ensuring your operation meets applicable standards and any other safety, security, or other requirements.

Copyright © 2023, Nicslab.

Safety Note

Do not operate this product in any manner not specified by Nicslab. Failure to comply with these precautions or with specific warnings or instructions elsewhere in this manual violates safety standards of design, manufacture, and intended use of the instrument. Nicslab assumes no responsibility for any damage caused by mishandling that is beyond normal usage defined in this manual of this product.

Before Applying DC Power Supply

Verify that the DC power supply is in good condition and safe to use. It is imperative to use ONE DC power supply as a source power for this product and the input voltage is no more than ± 18 V, or it can impair this product. Make all connections to the unit before applying power.

Do Not Discard the Instrument Cover

Only authorized personnel from Nicslab should remove the instrument cover.

Do Not Alter the Instrument

Do not put any unauthorized parts or modify the instrument without Nicslab approval and warranty.

Caution

This symbol indicates the hazard of any operating procedure, practice, or the like that, if not correctly performed or adhered to, could result in damage to the product or loss of important data.

Contents

List of Tables	4
List of Figures	4
1. Introduction	5
2. Hardware	7
Specification Conditions	7
Hardware Requirement	7
Box Descriptions	8
XDAC-8MUB-R4G8 Specifications	11
Hardware Installation	14
3. Software and Graphical User Interface (GUI)	15
Software Requirement	15
Software Installation	15
Graphical User Interface (GUI)	15
Initializing the GUI	18
Premium Upgrade	18
Constant Current Mode (CC Mode)	20
Constant Voltage Mode (CV Mode)	20
Value Increment Setting	21
Save and Upload	21
Sequence Automation	23
Record	24
Settings	25
4. Operating XDAC through the SCPI command	30
Python Installation (Example)	30
Run Python Code (Example)	31
Python Function (Example)	33
SCPI Commands	36
5. System Shutdown	40
6. Troubleshooting	41
7. Warranty	42
8. Compliance	42
9. Contact	42

List of Tables

Table 1. Checklist Items	6
Table 2. Specification Conditions	7
Table 3. DAC Voltage Performance Specification	11
Table 4. Current Limit and Buffer Performance Specification	12
Table 5. Voltage Control Resolution	14
Table 6. Current Control Resolution	14
Table 7. Troubleshooting	41

List of Figures

Figure 1. XDAC-8MUB-R4G8 System Diagram	6
Figure 2. Product Dimension	8
Figure 3. Front, Back and Top View	9
Figure 4. GUI	16

1. Introduction

Nicslab XDAC-8MUB-R4G8 system is a versatile multichannel source measurement system. The XDAC-8MUB-R4G8 supports multiple voltage/current sourcing and voltage/current measurement. The system is suitable for sourcing and measuring low-power applications from simple electronic circuits to complex photonic integrated circuits.

The XDAC-8MUB-R4G8 provides independent 8 channels controlled by Graphical User Interface (GUI) and Standard Commands for Programmable Instruments (SCPI) through an Ethernet port. The system has two modes: Constant Current (CC) ranging from 5 to 500 mA (source and sink) per channel and Constant Voltage (CV) ranging from bipolar ± 2.5 Volt, ± 5 Volt, ± 10 Volt, and ± 16 Volt per channel (please check your feature selection).

The features for XDAC-8MUB-R4G8 in detail are:

- 16-bits voltage control, see the resolution at Table 5.
- 16-bits current control, see the resolution at Table 6.
- Enable voltage range configuration through software (technology that enables the user to select the output range with software without losing control of the high-resolution feature).
- Flexible output configuration with 16-bit resolution: ± 2.5 V, ± 5 V, ± 10 V, ± 16 V (*Premium Upgrade*).
- Flexible current output configuration with 16-bit resolution 5 – 500 mA.
- Measurement time for single channel: 5.492 ms.
- Intuitive GUI.
- The maximum power output per channel is 10 watts.
- Real time voltage reading (16-bits resolution = 1.25 mV).
- Real time current reading (16-bits resolution = 5 μ A).
- Save function to create a database.
- Upload function to generate the registrable voltage and current pattern.
- Sequence function for continuous voltage and current.
- Short circuits protection.
- SCPI command support (Python, C#, Matlab, and LabVIEW).
- SCPI Library (*Premium Upgrade*).
- Windows, Mac, and Linux support.
- Ethernet port.

The XDAC-8MUB-R4G8 needs to be connected with DC Power then you can plug it into the Device-Under-Test (DUT). The voltage/current can be controlled through GUI or SCPI command via Ethernet/Ethernet to USB port converter.

The system diagram is as follows:

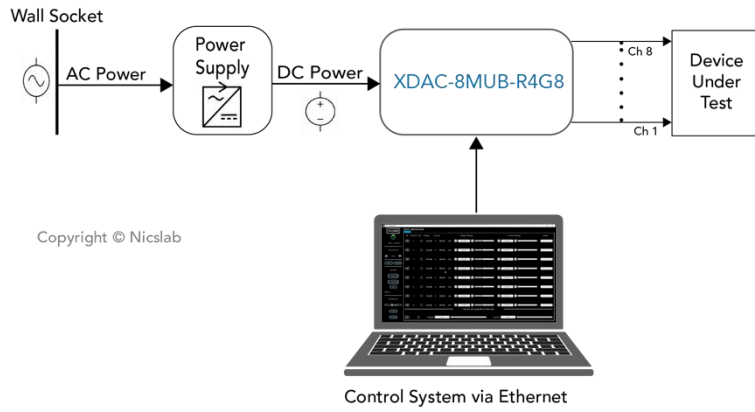

Figure 1. XDAC-8MUB-R4G8 System Diagram

The package should include the following items:

Table 1. Checklist Items

No	Item	Qty (pc)	Checklist
1	XDAC-8MUB-R4G8 Box	1	
2	DC power line cord (Red, Green, Black)	3	
3	Ethernet cable	1	
4	USB 2.0 Ethernet Network Adaptor	1	
5	USB flash disk	1	
6	Inside USB flash disk: a. GUI Installer b. Specification & Manual c. Test Report d. Serial key (Upgrade) e. XDAC key f. Software Library (Premium) g. Comma-separated values (CSV) template (upload, demo sequence)	1	

2. Hardware

Specification Conditions

The operating and measurement conditions are under the following conditions:

Table 2. Specification Conditions

Items	Conditions
Room Temperature	0 ~ 40 °C
Humidity	5 ~ 80 % (No Condensing)
Power Supply Input	DC Supply Max +18 V (potential at red & green DC in). DC Supply Min -18 V (potential at black & green DC in). Effective voltage output range ± 16 V. Power up minimum 18 watt (+18 V, 0.5 A and -18 V, 0.5 A power supply setting). Required headroom 1.4 – 2 V.
Waterproof/Dustproof	To be operated under room condition
Calibration period	2 years

Note:

- To minimize the possibility of overheating the device, it is recommended that the supply voltage value should be the maximum output to be generated + 3 volts. For example, if you have a DUT that needs to be driven by 100mA current with a voltage of 10V, then the recommended power supply setting is 10 + 3 Volts which is 13 Volts.
- Maximum current output for 8 channels simultaneously is 300 mA.
- Maximum channel control for 500mA output is 6 channels simultaneously.

Hardware Requirement

The requirements for the PC/Laptop to be used for this product installation are:

- Resolution Min. 1024 x 768 pixel
- Hard disk Min. 500 MB of available free space (32-bit and 64-bit operating system)
- USB Port USB 2.0
- RAM Min. 2 GB
- CPU 2.4 GHz or faster
- Ethernet port or internet connection via a router.

Box Descriptions

The box size is 141 (W) x 186.99 (L) x 91 (H) mm, with a weight of 0.9 kg, as shown in the pictures below:

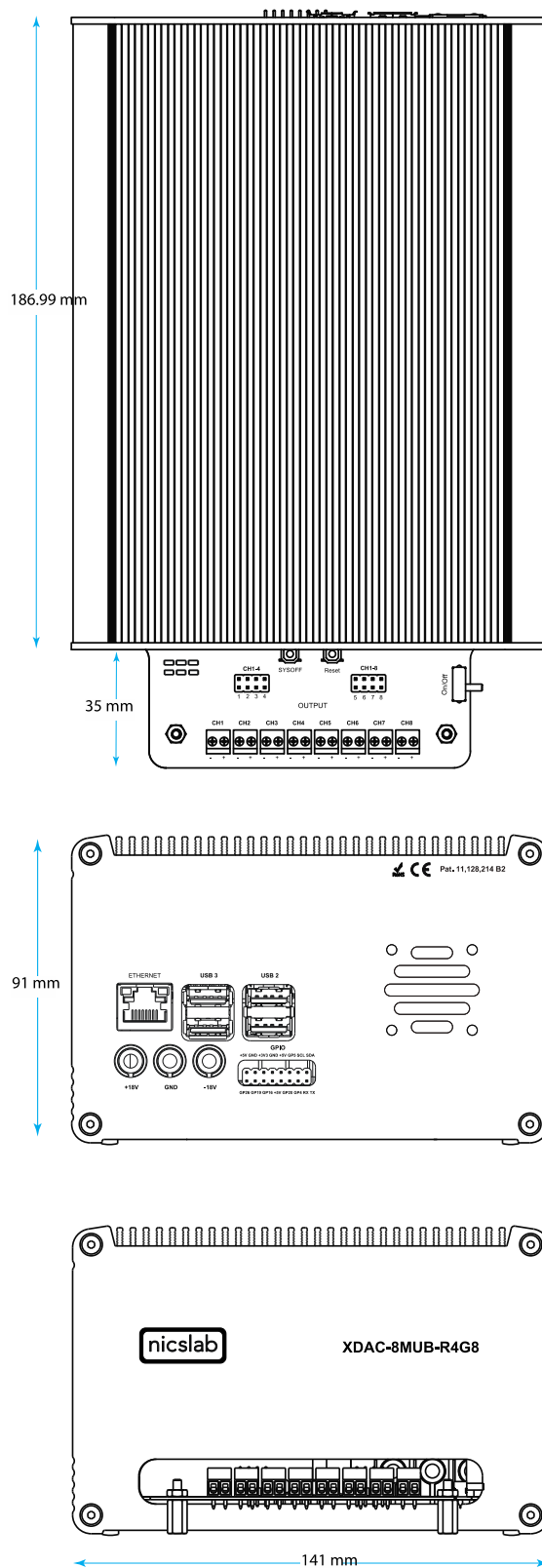

Figure 2. Product Dimension

The details of the front, back, and top panels of the box are described below:

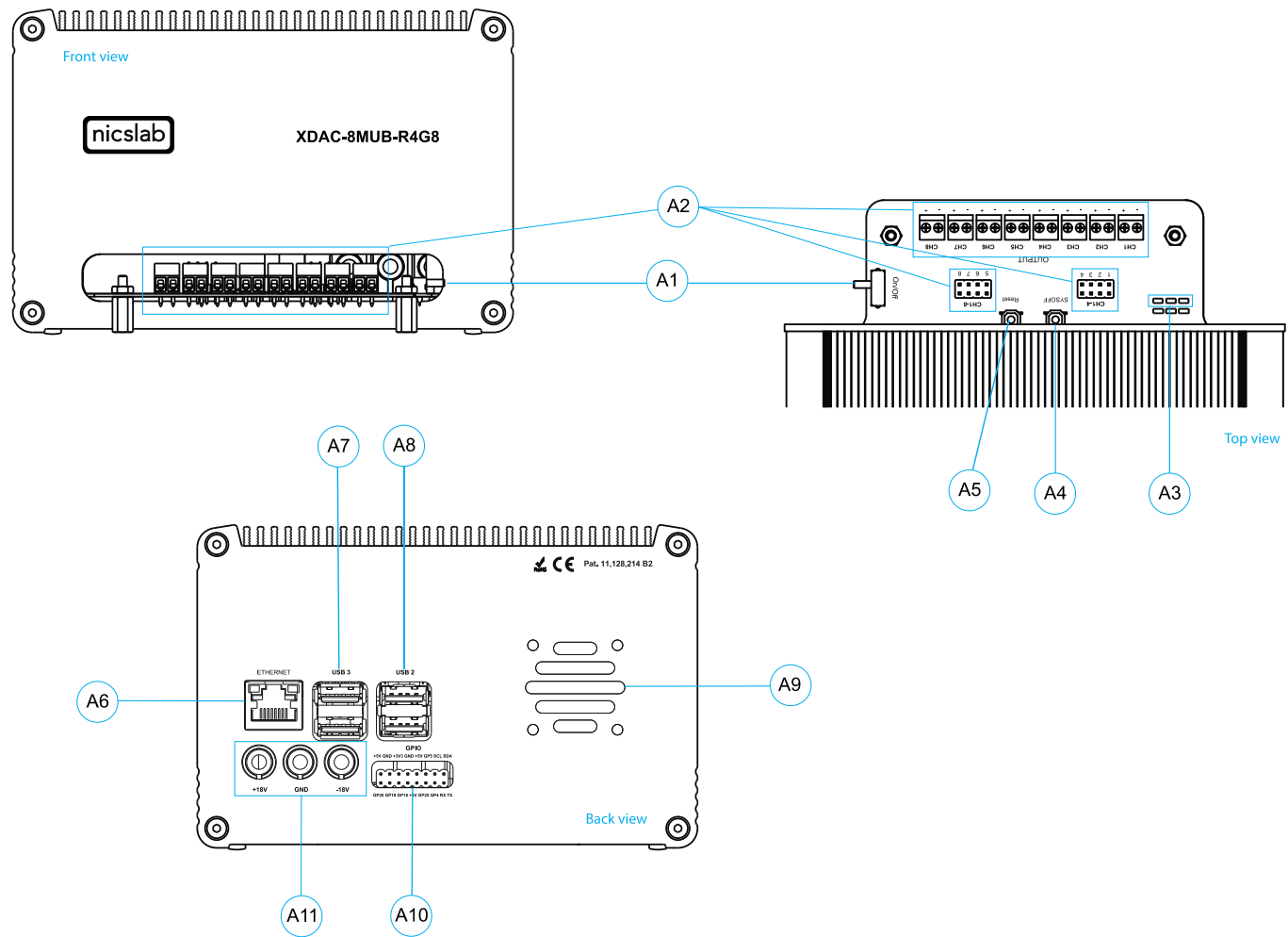

Figure 3. Front, Back and Top View

Note:

A1	Power Switch	Turns the instrument on or off. Caution Before turning OFF please close the GUI or type shutdown (SCPI command) to minimize the risk of corrupting the system file (such as data loss).
A2	Pin Output (8 channels)	To connect to Device Under Test (DUT) using a cable.
A3	Indicator Light	Red -> Power Indicator. Green -> Ready to connect. Yellow -> Transfer Data Active (Connected).
A4	YSOFF Button	To shut down the XDAC.
A5	Reset Button	To reset the XDAC.
A6	Ethernet port	Use ethernet cable to connect. An ethernet to USB port converter is also possible to be used if the computer doesn't have an ethernet port.
A7	USB 3.0	USB port version 3.0.
A8	USB 2.0	USB port version 2.0.
A9	Airflow Exhaust Hole	For air circulation inside the box.
A10	GPIO	You may use it for external control and direct monitoring of the microprocessor.
A11	Input DC Max ± 18 V	Caution Please follow the safety notice on your DC power supply. USE ONLY ONE DC POWER SUPPLY and the input is no more than ± 18 V. The XDAC will not power up if the current from the power supply is too low (minimum 0.5 A). Green cable inserts to 0 V Black cable inserts to negative terminal (-18 V) Red cable inserts to positive terminal (+18 V)

XDAC-8MUB-R4G8 Specifications

The performance specifications of Digital Analog Converter (DAC) voltage are listed in Table 3 below:

Table 3. DAC Voltage Performance Specification

No	Parameter	Min	Typ	Max	Unit	Test conditions/comments
1	Resolution	16			Bits	
2	Integral nonlinearity (INL)	-1	± 0.5	1	LSB	All ranges, except ±2.5 V
3	Differential Nonlinearity (DNL)	-1	± 0.5	1	LSB	Specified 16-bit monotonic
4	Total unadjusted error	-0.1	± 0.01	0.1	%FSR	All ranges except ±2.5 V
5	Unipolar offset error	-0.03	± 0.015	0.03	%FSR	All unipolar ranges
6	Unipolar zero-code error	0	0.04	0.1	%FSR	All unipolar ranges
7	Bipolar zero-code error	0	0.04	0.1	%FSR	All bipolar ranges
8	Full-scale error	-0.2	± 0.075	± 0.2	%FSR	All ranges
9	Gain error	-0.1	± 0.02	0.1	%FSR	All ranges except ±2.5 V
10	Unipolar offset error drift		±2		ppm of FSR/°C	All unipolar ranges
11	Bipolar offset error drift		±2		ppm of FSR/°C	All bipolar ranges
12	Gain error drift		±2		ppm of FSR/°C	All ranges
13	Output voltage drift over time		5		Ppm of FSR	T _A = 40 °C, Full-scale code, 1900 hours
DYNAMIC PERFORMANCE						
14	Output Voltage Settling Time		12		µs	¼ to ¾ and ¾ to ¼ scale setting time to ± 1 LSB, ±10 V range, R _L = 5 kΩ, C _L = 200 pF
15	Slew Rate		4		V/µs	All ranges except 0 to 5 V
16	Power-on glitch magnitude		0.3		V	Power-down to active DAC output, ±20 V range, Midscale code, R _L = 5 kΩ, C _L = 200 pF
17	Output noise		15		µV p-p	0.1 Hz to 10 Hz, Midscale code, 0 to 5 V range
18	Output noise density		78		nV/√Hz	1 kHz, Midscale code, 0 to 5 V range
19	AC PSRR		1		LSB/V	Midscale code, frequency = 60 Hz, amplitude 200 mVpp superimposed on V _{DD} , V _{CC} , or V _{SS}
20	DC PSRR		1		LSB/V	Midscale code, V _{DD} = 5 V, V _{CC} = 20 V ±5 %, V _{SS} = 20 V
21	Code change glitch impulse		4		nV-s	1 LSB change around the major carrier, 0 to 5 V range
22	Channel to Channel AC crosstalk		4		nV-s	0 to 5 V range. Measured channel at midscale. Full-scale swing on all other channels.
23	Channel to Channel DC crosstalk		0.25		LSB	0 to 5 V range. Measured channel at midscale. All other channels at full-scale.
23	Digital feedthrough		1		nV-s	0 to 5 V range, Midscale code, F _{SCLK} = 1 MHz

The performance specifications of the current buffer circuit are listed in Table 4 below:

Table 4. Current Limit and Buffer Performance Specification

No	Parameter	Min	Typ	Max	Unit	Test conditions/comments
POWER OP AMP CHARACTERISTICS						
1	Input offset voltage		200	600	μV	
				1000	μV	$0\text{ }^\circ\text{C} < \text{TA} < 70\text{ }^\circ\text{C}$
				1300	μV	$-40\text{ }^\circ\text{C} < \text{TA} < 85\text{ }^\circ\text{C}$
2	Input offset voltage drift	-10	-4	10	$\mu\text{V}/^\circ\text{C}$	
3	Input offset current	-100		100	nA	$V_{\text{CM}} = 0\text{ V}$
4	Input bias current	-600	-160		nA	$V_{\text{CM}} = 0\text{ V}$
5	Input noise voltage		3		$\mu\text{V}_{\text{P-P}}$	
6	Input noise voltage density		15		$\mu\text{V}/\sqrt{\text{Hz}}$	
7	Input noise current density		3		$\text{pA}/\sqrt{\text{Hz}}$	
8	Input resistance		500			Common mode
			100			Differential mode
9	Input capacitance		6		pF	Pin 8 and Pin 9 to Ground
10	Input voltage range	-14.5		13.6	V	Typical
		-12.0		12.0	V	Guaranteed by CMRR test
11	Common mode rejection ratio	92	105		dB	$-12\text{ V} < V_{\text{CM}} < 12\text{ V}$
12	Power supply rejection ratio	90	100		dB	$V_{\text{EE}} = V_- = -5\text{ V}$, $V_{\text{CC}} = V_+ = 3\text{ V}$ to 30 V
		110	130		dB	$V_{\text{EE}} = V_- = -5\text{ V}$, $V_{\text{CC}} = 30\text{ V}$, $V_+ = 2.5\text{ V}$ to 30 V
		90	100		dB	$V_{\text{EE}} = V_- = -3\text{ V}$, $V_{\text{CC}} = V_+ = 5\text{ V}$
		110	130		dB	$V_{\text{EE}} = -30\text{ V}$, $V_- = -2.5\text{ V}$ to -30 V , $V_{\text{CC}} = V_+ = 5\text{ V}$
13	Large-signal voltage gain	75			V/mV	$R_{\text{L}} = 1\text{ k}\Omega$, $-12.5\text{ V} < V_{\text{OUT}} < 12.5$
		40			V/mV	$R_{\text{L}} = 100\ \Omega$, $-12.5\text{ V} < V_{\text{OUT}} < 12.5\text{ V}$
		5			V/mV	$R_{\text{L}} = 10\ \Omega$, $-5\text{ V} < V_{\text{OUT}} < 5\text{ V}$, $V_+ = -V_- = 8\text{ V}$
14	Output sat voltage low		1.9	2.5	V	$V_{\text{OL}} = V_{\text{OUT}} - V_-$ $R_{\text{L}} = 100$, $V_{\text{CC}} = V_+ = 15\text{ V}$, $V_{\text{EE}} = V_- = -15\text{ V}$
15	Output sat voltage high		1.7	2.3	V	$V_{\text{OH}} = V_+ - V_{\text{OUT}}$ $R_{\text{L}} = 100$, $V_{\text{CC}} = V_+ = 15\text{ V}$, $V_{\text{EE}} = V_- = -15\text{ V}$
16	Output short-circuits current	500	800	1200	mA	Output Low, $R_{\text{SENSE}} = 0\ \Omega$
		-1000	-800	-500	mA	Output High, $R_{\text{SENSE}} = 0\ \Omega$
17	Slew rate	0.7	1.6		V/ μs	
18	Full power bandwidth	11			kHz	$V_{\text{OUT}} = 10\text{ V}_{\text{PEAK}}$
19	Gain bandwidth product		3.6		MHz	$f = 10\text{ kHz}$

20	Settling time		8		μV	0.01 %, $V_{\text{OUT}} = 0 \text{ V}$ to 10 V , $A_V = -1$, $R_L = 1 \text{ k}\Omega$
CURRENT SENSE CHARACTERISTICS						
21	Minimum current sense voltage	0.1		10	mV	$V_{\text{CSRC}} = V_{\text{CSNK}} = 0 \text{ V}$
22	Current sense voltage 4% of full scale	15	20	25	mV	$V_{\text{CSRC}} = V_{\text{CSNK}} = 0.5 \text{ V}$
23	Current sense voltage 10% of full scale	45	50	55	mV	$V_{\text{CSRC}} = V_{\text{CSNK}} = 0.5 \text{ V}$
24	Current sense voltage 100% of full scale	480	500	520	mV	$V_{\text{CSRC}} = V_{\text{CSNK}} = 5 \text{ V}$
25	Current limit control input bias current	-1	-0.2	0.1	μA	$V_{\text{CSRC}}, V_{\text{CSNK}}$ Pins
26	SENSE- input current	-500		500	nA	$0 \text{ V} < (V_{\text{CSRC}}, V_{\text{CSNK}}) < 5 \text{ V}$
27	FILTER input current	-500		500	nA	$0 \text{ V} < (V_{\text{CSRC}}, V_{\text{CSNK}}) < 5 \text{ V}$
28	SENSE+ input current	-500		500	nA	$V_{\text{CSRC}} = V_{\text{CSNK}} = 0 \text{ V}$
		200	250	300	nA	$V_{\text{CSRC}} = 5 \text{ V}, V_{\text{CSNK}} = 5 \text{ V}$
		-300	-250	-200	nA	$V_{\text{CSRC}} = 0 \text{ V}, V_{\text{CSNK}} = 5 \text{ V}$
		-25		25	nA	$V_{\text{CSRC}} = V_{\text{CSNK}} = 5 \text{ V}$
29	Current sense change with output voltage		± 0.1		%	$V_{\text{CSRC}} = V_{\text{CSNK}} = 5 \text{ V}, -12.5 \text{ V} < V_{\text{OUT}} < 12.5 \text{ V}$
30	Current sense change with supply voltage		± 0.05		%	$V_{\text{CSRC}} = V_{\text{CSNK}} = 5 \text{ V}, 6 \text{ V} < (V_{\text{CC}}, V_+) < 18 \text{ V}$
			± 0.01		%	$2.5 \text{ V} < V_+ < 18 \text{ V}, V_{\text{CC}} = 18 \text{ V}$
			± 0.05		%	$-18 \text{ V} < (V_{\text{EE}}, V_-) < -2.5 \text{ V}$
			± 0.01		%	$-18 \text{ V} < V_- < -2.5 \text{ V}, V_{\text{EE}} = -18 \text{ V}$
31	Current sense bandwidth		2		MHz	
32	Resistance FILTER to SENSE-	750	1000	1250	Ω	
LOGIC I/O CHARACTERISTICS						
33	Logic output leakage			1	μA	$V = 15 \text{ V}$
34	Logic low output level		0.2	0.4	V	$I = 5 \text{ mA}$
35	Logic output current limit		25		mA	
36	Enable logic threshold	0.8	1.9	2.5	V	
37	Enable pin bias current	-1		1	μA	
38	Total supply current		7	13	mA	V_{CC}, V_+ and V_-, V_{EE} connected
39	V_{CC} supply current		3	7	mA	V_{CC}, V_+ and V_-, V_{EE} separate
40	Supply current disabled		0.6	1.5	mA	V_{CC}, V_+ and V_-, V_{EE} connected, V_{ENABLE}
41	Turn-On delay		10		μs	
42	Turn-Off delay		10		μs	

The voltage control resolution is listed in Table 5 below. The resolution is 16-bits and have different value for each range. The default range is ± 20 V (± 16 V) and can be adjusted in GUI premium version.

Table 5. Voltage Control Resolution

No	Range	Resolution
1	± 20 V (± 16 V)	0.6 mV
2	± 10 V	0.3 mV
3	± 5 V	150 μ V
4	± 2.5 V	76 μ V

The current control resolution is listed in Table 6 below. The resolution is 16-bits and have a fixed range of 0 – 500 mA. The controllable range is 5 – 500 mA.

Table 6. Current Control Resolution

No	Range	Resolution
1	0 – 500 mA	7.6 μ A

Hardware Installation

This section describes how to install XDAC-8MUB-R4G8 and how to connect your Device Under Test (DUT) to the output terminals.

The steps are as follows:

1. Precondition step: connect to the DC power supply (max ± 18 V). Make certain that the DC power supply is always 'ON'.
2. Connect an Ethernet cable to your workstation (PC/Laptop) via Ethernet Port or USB 2.0 Ethernet Network Adapter.
3. Install the software/GUI (see the Software Installation section) from the flash disk or Dropbox link.
4. Turn ON the switch (indicator light: **Red**).
5. Wait until there is **Green** light (the system is ready to use).
6. You may now open the GUI (there is **Yellow** light that means serial data transfer is active).
7. Connect XDAC output to your Device Under Test (DUT).

3. Software and Graphical User Interface (GUI)

Software Requirement

The GUI software is suitable for the following operating systems:

- Windows® 7 (32-bit, 64-bit).
- Windows® 10 (32-bit, 64-bit).
- Windows® 11 (64-bit).
- macOS Big Sur.

Software Installation

The first step is to install the XDAC_setup.exe file into your computer and then double-click to launch the GUI. The icon is as below:

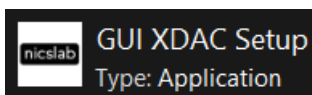

At the end step of the installation, check a 'Create a desktop shortcut'.

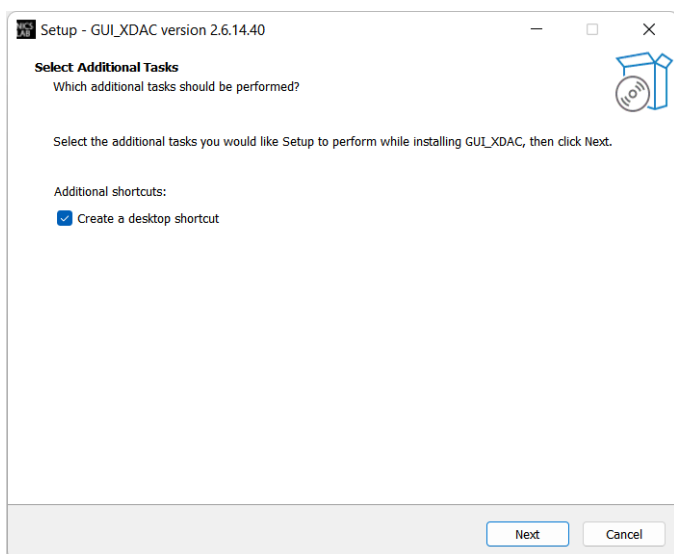

Double-click the executable GUI icon (as shown below) on your desktop to launch the GUI.

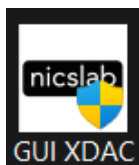

Graphical User Interface (GUI)

Start the XDAC by pressing the ON button, then you can control it by GUI. the display details are on the next page.

First, set up the connection to your instruments by entering the IP address. Please scan the XDAC IP address to know the XDAC IP. The XDAC IP address should appear if you scan it in the local network using an IP scanner such as Angry IP Scanner or NMAP.

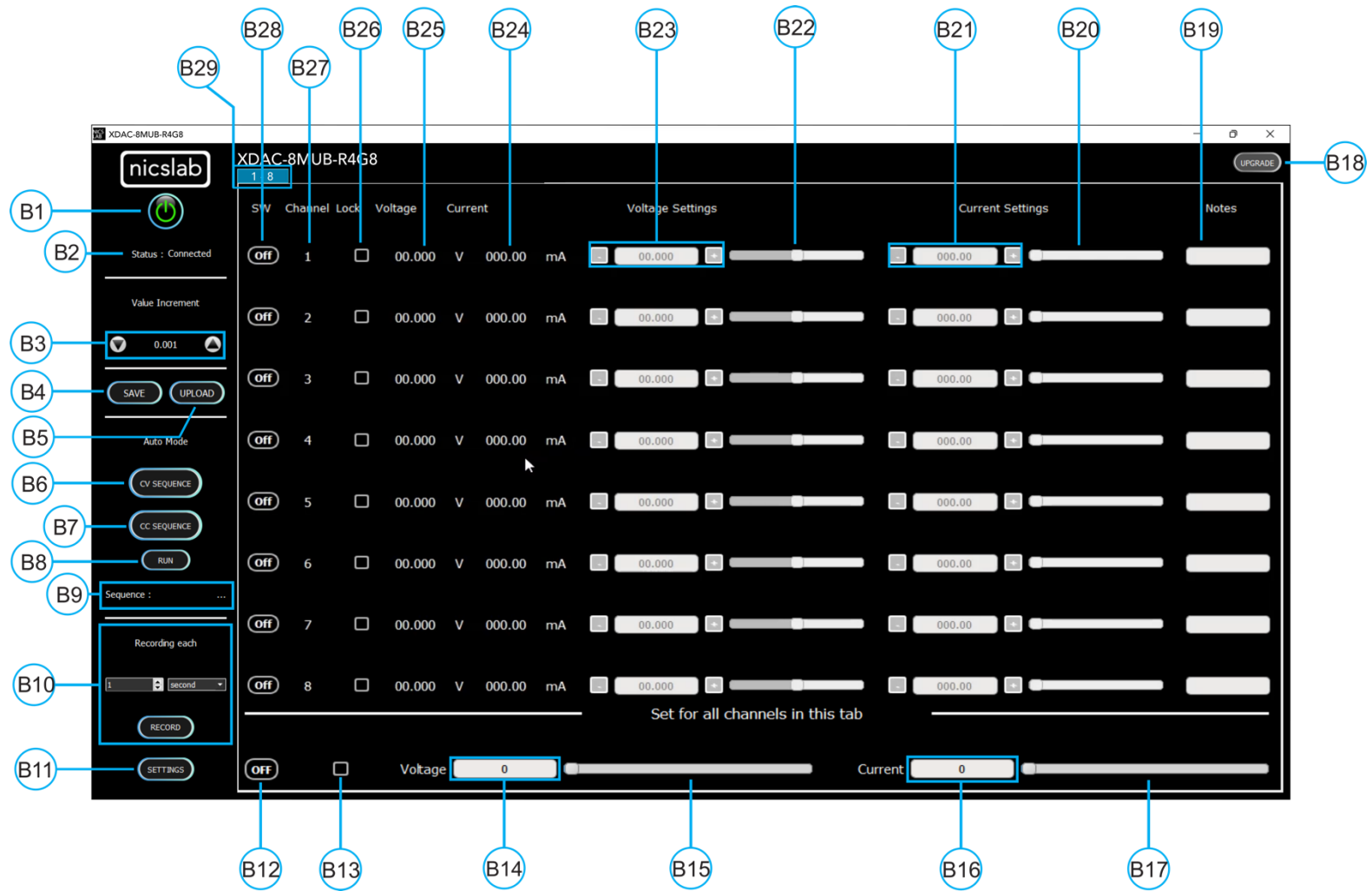

Figure 4. GUI

Note:

Callout	Description
B1	ON/OFF Switch
B2	Status of connection
B3	Increment Settings
B4	Save File Button - <i>Premium Feature</i>
B5	Upload File Button - <i>Premium Feature</i>
B6	Auto Feature Sequence: Upload Table Button I CV Mode - <i>Premium Feature</i>
B7	Auto Feature Sequence: Upload Table Button I CC Mode - <i>Premium Feature</i>
B8	Auto Feature: Run Button CV and/or CC Mode - <i>Premium Feature</i>
B9	Name of the Sequence - <i>Premium Feature</i>
B10	1. Record Data Button - <i>Premium Feature</i>
B11	Setting for: 2. Set Limit voltage and current values - <i>Premium Feature</i> 3. V Range (16-bit precision for every range of voltages: $\pm 2.5\text{ V}$, $\pm 5\text{ V}$, $\pm 10\text{ V}$, $\pm 16\text{ V}$) - <i>Premium Feature</i> Set the Reading speed of Voltage and Current (Fast, Medium, Slow) - <i>Premium Feature</i>
B12	ON/OFF Button for the current Tab
B13	Enable/Disable (Lock) Channel Controller for all channels in the current tab
B14	Text area to set the voltage for all channels in the current tab
B15	Slider to set the voltage for all channels in the current tab
B16	Text area to set the current for all channels in the current tab
B17	Slider to set current for all channels in the current tab
B18	Upgrade Button
B19	Notes - <i>Premium Feature</i>
B20	Current Settings Slider
B21	Current Value Based on Increment Setting
B22	Voltage Settings Slider
B23	Voltage Value Based on Increment Setting
B24	Current Value
B25	Voltage Value
B26	Enable/Disable (Lock) Channel Controller
B27	Number of channels
B28	ON/OFF Button per Channel
B29	Tab Channel

Initializing the GUI

This section shows how to initialize the GUI:

1. Launch the program by double-clicking the "XDAC_setup_exe" icon.
2. Enter XDAC IP address as given. If the connection is successful, then the GUI will open and the Yellow indicator light will be on.

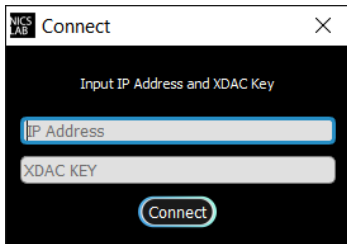

3. Press the 'ON/OFF' button (B1) to start the GUI.



4. Turn ON (B28) on each channel to the input voltage and current values.

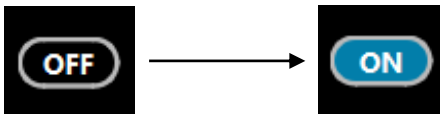

Premium Upgrade

This section shows how to upgrade the GUI to enable advanced features.

1. Press the upgrade button (B18) at the top right corner of the window

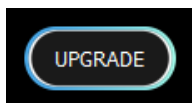

2. After the upgrade window opened, input the Premium Upgrade Key.

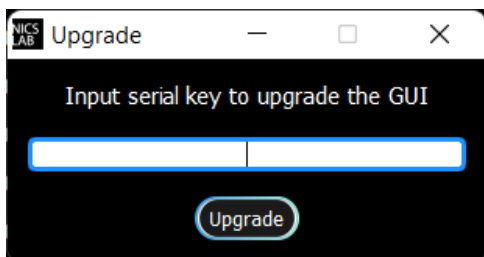

3. If your Premium Upgrade Key is valid, you will get a message that indicates a successful upgrade.

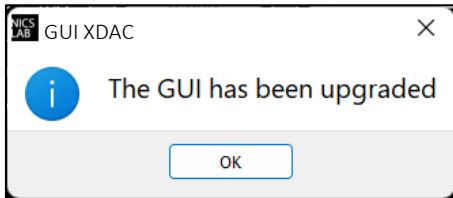

4. You can use several features that were previously locked

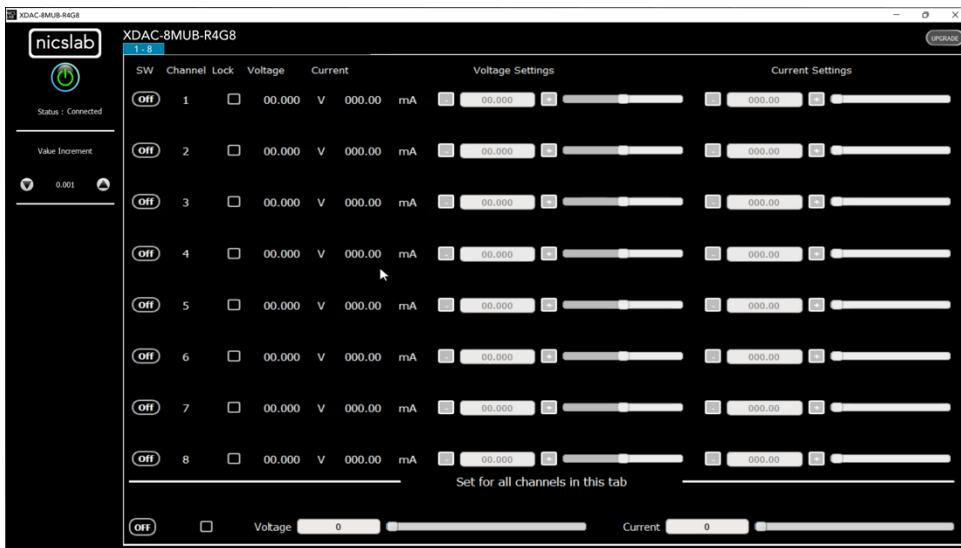

The next few sections are the advanced features that are enabled after upgrading the GUI.

Constant Current Mode (CC Mode)

This section shows how to do CC mode according to your purpose:

To do CV mode, you need to move the voltage slider (B22) or adjust the voltage value (B23) to a certain value before setting the current value on (B21) or slider (B20). As an example, channel 1 in the below picture was given a 100 Ω load.

Important note: When you manually input the values, always press 'Enter'.



Constant Voltage Mode (CV Mode)

This section shows how to do CV mode according to your aim:

To do CV mode, you need to move the current slider (B20) or adjust the current value (B21) to a certain value. Then adjust the voltage value on (B23) or slider (B22).

Important note: When you manually input the values, always press 'Enter'.



Value Increment Setting

In this setting, the value of the voltage and current can be incrementally changed from a minimum of 0.001 to 1. Adjust the arrow to increase and decrease the value increment (B3).

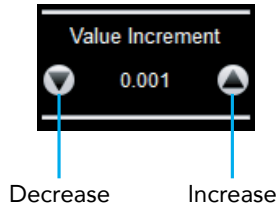

Save and Upload

The CSV file (.csv) resulting from the Save function can be uploaded again through the Upload button (B5). You may also create your own CSV file of voltage and current and upload it later.

1. To save the configuration, click the 'Save' button (B4).



2. Select a directory and write the file name.

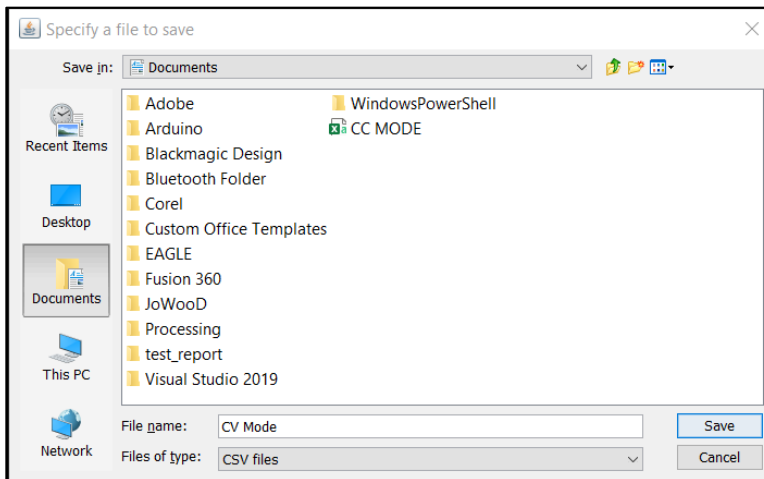

3. The file will be saved as a .csv file.
4. Check the .csv file that you have saved.

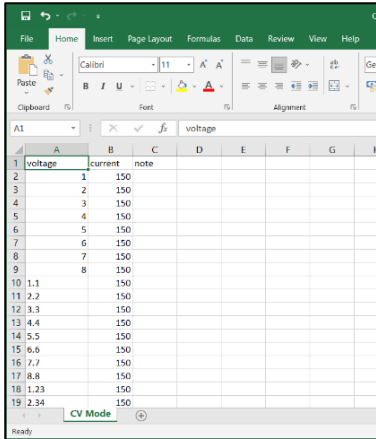

The voltage, current, and notes are recorded. If the file doesn't appear to have saved data from all channel, consider trying to open the file with another program, like Notepad, for further inspection.

- To upload the configuration, click the 'Upload' button (B5).



- Choose and open the intended file.

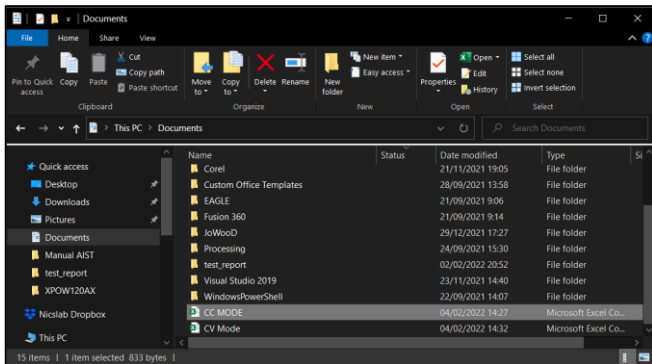

- It will upload the configuration like the previous configuration.

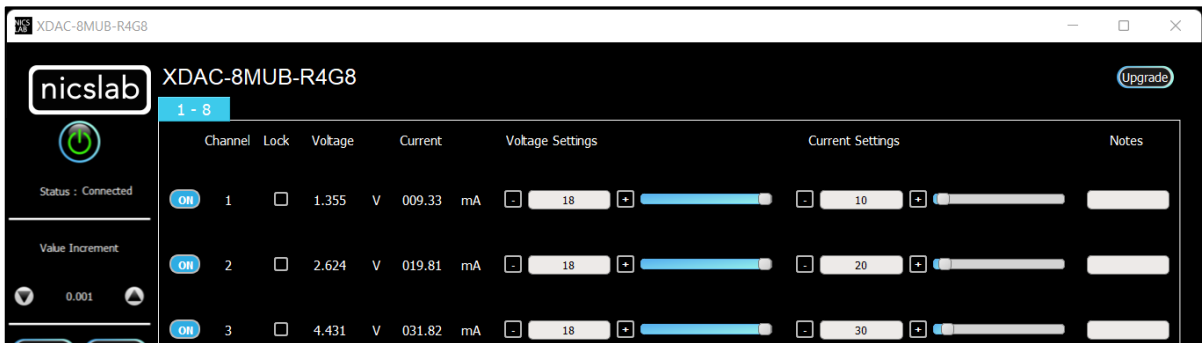

Note: When you upload CV mode, the current setting slider values automatically show 2184.50 bits to open the current flow from the supply. You may adjust this to match your requirements.

Sequence Automation

Sequence is the setting that automates the determined values of current (mA) or voltage (V) given the certain Delay Time (in milliseconds).

1. The template of the Sequence is given, then you need to input your intended values of CC Sequence (from 5 to 500 mA), CV Sequence (± 16 V), and Delay Time (in milliseconds). Set the delay time to more than 2 seconds to have more accurate values. To have a faster response (switching time) you can set it via the SCPI command (see Operating XDAC through the SCPI command).

	A	B	C	D	E	F	G	H	I	J
1		Seq 1	Seq 2	Seq 3	Seq 4	Seq 5	Seq 6	Seq 7	Seq 8	Note
2	Delay Time	6000	5478	4912	3409	4213	5902	6012		
3	Channel 1	5	50	0	100	150	150	0	300	Fan1
4	Channel 2	10	50	0	100	160	150	0	300	Fan2
5	Channel 3	15	50	0	100	170	150	0	300	Motor1
6	Channel 4	20	50	0	100	180	150	0	300	Motor2
7	Channel 5	25	50	0	100	190	150	0	300	Sensor1
8	Channel 6	30	50	0	100	200	150	0	300	Sensor2
9	Channel 7	35	50	0	100	210	150	0	300	Sensor3
10	Channel 8	40	50	0	100	220	150	0	300	Not Used

Note:

- A. Template given for CC and CV sequences.
 - B. Input your intended values according to the modes (CC: 5 – 500 mA, CV: ± 16 V).
2. Choose the sequence mode that you will use, either CV Sequence (B6) or CC sequence (B7). When you click, for example, if you want to use a CC sequence, you need to open the corresponding CSV sequence file.
 3. After uploading, choose sequence mode by clicking Run' (B8). It will run either CC, CV, or CC & CV Sequence depends on the .csv file that you uploaded before.

Important note: when 'Run CCCV' use the same delay time on the template .csv of CC and CV sequence.

Record

'Record' (B10) keeps data on voltage and current values. You can choose how often the data is stored in a unit of time. The default value is the data will be stored each one second. The record starts by the time you click the Record button and finish when you click again the same button.



Click the same button to stop Recording. After that, put the file in any directory

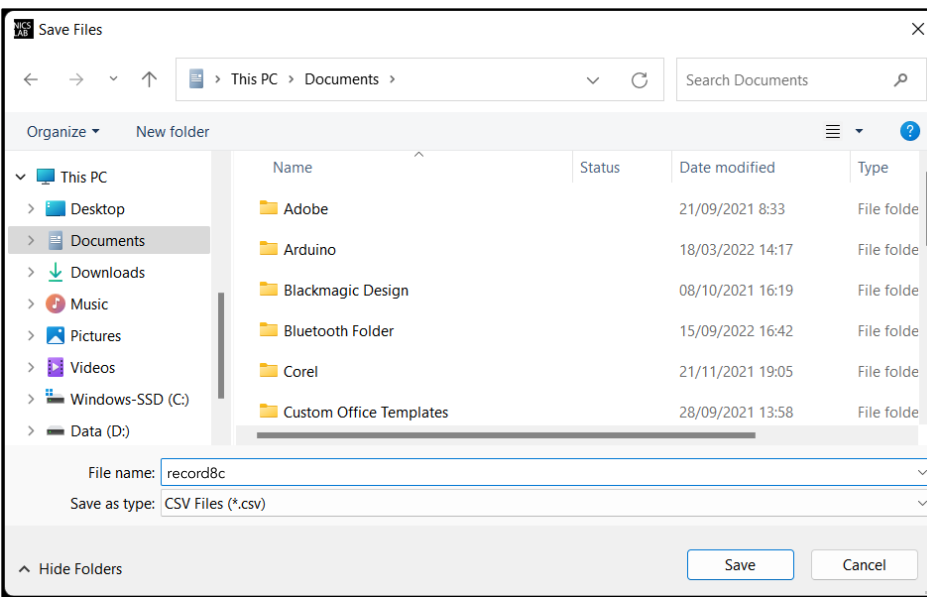

This is the output of the recorded file

A1	Time Stamp	Voltage[1]	Current[1]	Notes	Voltage[2]	Current[2]	Notes	Voltage[3]	Current[3]	Notes	Voltage[4]	Current[4]	Notes	Voltage[5]	Current[5]	Notes	Voltage[6]	Current[6]	Notes
2	20:29:19	1.111 V	9.1 mA	Fan1	1.053 V	9.17 mA	Fan2	1.125 V	9.12 mA	Motor1	1.107 V	9.12 mA	Motor2	1.099 V	9.07 mA	Sensor1	1.112 V	9.05 mA	Sensor2
3	20:29:20	1.111 V	9.07 mA	Fan1	1.053 V	9.17 mA	Fan2	1.125 V	9.12 mA	Motor1	1.107 V	9.12 mA	Motor2	1.099 V	9.07 mA	Sensor1	1.112 V	9.05 mA	Sensor2
4	20:29:21	1.111 V	9.1 mA	Fan1	1.053 V	9.17 mA	Fan2	1.125 V	9.12 mA	Motor1	1.107 V	9.12 mA	Motor2	1.1 V	9.07 mA	Sensor1	1.112 V	9.05 mA	Sensor2
5	20:29:22	1.111 V	9.1 mA	Fan1	1.053 V	9.17 mA	Fan2	1.125 V	9.12 mA	Motor1	1.107 V	9.12 mA	Motor2	1.099 V	9.07 mA	Sensor1	1.112 V	9.05 mA	Sensor2
6	20:29:23	1.111 V	9.1 mA	Fan1	1.053 V	9.17 mA	Fan2	1.125 V	9.12 mA	Motor1	1.107 V	9.12 mA	Motor2	1.1 V	9.07 mA	Sensor1	1.112 V	9.05 mA	Sensor2
7	20:29:24	1.111 V	9.1 mA	Fan1	1.053 V	9.17 mA	Fan2	1.125 V	9.12 mA	Motor1	1.107 V	9.12 mA	Motor2	1.1 V	9.07 mA	Sensor1	1.112 V	9.05 mA	Sensor2
8	20:29:25	8.716 V	71.8 mA	Fan1	1.054 V	9.17 mA	Fan2	1.125 V	9.12 mA	Motor1	1.107 V	9.12 mA	Motor2	1.1 V	9.07 mA	Sensor1	1.112 V	9.05 mA	Sensor2
9	20:29:26	8.716 V	71.8 mA	Fan1	1.054 V	9.17 mA	Fan2	1.125 V	9.12 mA	Motor1	1.107 V	9.12 mA	Motor2	1.1 V	9.07 mA	Sensor1	1.112 V	9.05 mA	Sensor2
10	20:29:27	8.716 V	71.8 mA	Fan1	1.054 V	9.17 mA	Fan2	1.125 V	9.12 mA	Motor1	1.107 V	9.12 mA	Motor2	1.1 V	9.07 mA	Sensor1	1.112 V	9.05 mA	Sensor2
11	20:29:28	8.716 V	71.8 mA	Fan1	8.699 V	76.37 mA	Fan2	1.125 V	9.12 mA	Motor1	1.109 V	9.15 mA	Motor2	1.1 V	9.07 mA	Sensor1	1.112 V	9.05 mA	Sensor2
12	20:29:29	8.717 V	71.8 mA	Fan1	8.699 V	76.35 mA	Fan2	1.125 V	9.12 mA	Motor1	1.109 V	9.15 mA	Motor2	1.1 V	9.07 mA	Sensor1	1.112 V	9.05 mA	Sensor2
13	20:29:30	8.717 V	71.8 mA	Fan1	8.699 V	76.35 mA	Fan2	1.125 V	9.12 mA	Motor1	1.109 V	9.15 mA	Motor2	1.1 V	9.07 mA	Sensor1	1.112 V	9.05 mA	Sensor2
14	20:29:31	8.717 V	71.8 mA	Fan1	8.699 V	76.35 mA	Fan2	1.156 V	9.35 mA	Motor1	1.109 V	9.12 mA	Motor2	1.1 V	9.07 mA	Sensor1	1.112 V	9.05 mA	Sensor2
15	20:29:32	8.717 V	71.8 mA	Fan1	8.699 V	76.35 mA	Fan2	1.372 V	11.15 mA	Motor1	1.109 V	9.15 mA	Motor2	1.1 V	9.07 mA	Sensor1	1.112 V	9.05 mA	Sensor2
16	20:29:33	8.717 V	71.8 mA	Fan1	8.699 V	76.35 mA	Fan2	1.372 V	11.15 mA	Motor1	1.475 V	12.2 mA	Motor2	1.1 V	9.07 mA	Sensor1	1.114 V	9.05 mA	Sensor2
17	20:29:34	8.716 V	71.8 mA	Fan1	8.699 V	76.35 mA	Fan2	1.372 V	11.15 mA	Motor1	1.474 V	12.2 mA	Motor2	1.1 V	9.07 mA	Sensor1	1.112 V	9.05 mA	Sensor2
18	20:29:35	8.717 V	71.8 mA	Fan1	8.699 V	76.35 mA	Fan2	1.372 V	11.15 mA	Motor1	1.475 V	12.2 mA	Motor2	2.148 V	17.75 mA	Sensor1	1.114 V	9.05 mA	Sensor2
19	20:29:36	8.716 V	71.77 mA	Fan1	8.699 V	76.35 mA	Fan2	1.372 V	11.15 mA	Motor1	1.475 V	12.2 mA	Motor2	2.441 V	20.22 mA	Sensor1	1.72 V	13.82 mA	Sensor2
20	20:29:37	8.716 V	71.77 mA	Fan1	8.699 V	76.35 mA	Fan2	1.372 V	11.15 mA	Motor1	1.475 V	12.2 mA	Motor2	2.441 V	20.22 mA	Sensor1	3.7 V	30.27 mA	Sensor2
21	20:29:38	8.716 V	71.77 mA	Fan1	8.699 V	76.35 mA	Fan2	1.372 V	11.15 mA	Motor1	1.475 V	12.2 mA	Motor2	2.441 V	20.22 mA	Sensor1	3.7 V	30.27 mA	Sensor2

Settings

Click the 'Settings' button (B11).



The 'Settings' feature consists of:

- Set the maximum limit for both current and/or voltage values

Set Voltage Limit

SW	Channel	Lock	Voltage	Current	Voltage Settings	Current Settings	Notes
ON	1	<input type="checkbox"/>	00.000 V	00.00 mA	± 1	000.00	
ON	2	<input type="checkbox"/>	00.000 V	00.00 mA	± 5	000.00	
ON	3	<input type="checkbox"/>	00.000 V	00.00 mA	± 10	000.00	
ON	4	<input type="checkbox"/>	00.000 V	00.00 mA	± 10	000.00	
ON	5	<input type="checkbox"/>	00.000 V	00.00 mA	± 10	000.00	
ON	6	<input type="checkbox"/>	00.000 V	00.00 mA	± 10	000.00	
ON	7	<input type="checkbox"/>	00.000 V	00.00 mA	± 5	000.00	
ON	8	<input type="checkbox"/>	00.000 V	00.00 mA	± 1	000.00	

Set Current Limit

SW	Channel	Lock	Voltage	Current	Voltage Settings	Current Settings	Notes
ON	1	<input type="checkbox"/>	00.000 V	00.00 mA	± 1	50	
ON	2	<input type="checkbox"/>	00.000 V	00.00 mA	± 5	100	
ON	3	<input type="checkbox"/>	00.000 V	00.00 mA	± 10	150	
ON	4	<input type="checkbox"/>	00.000 V	00.00 mA	± 10	200	
ON	5	<input type="checkbox"/>	00.000 V	00.00 mA	± 10	200	
ON	6	<input type="checkbox"/>	00.000 V	00.00 mA	± 10	200	
ON	7	<input type="checkbox"/>	00.000 V	00.00 mA	± 5	200	
ON	8	<input type="checkbox"/>	00.000 V	00.00 mA	± 1	200	

Important note: When you input the values, always press 'Enter'.

- Set the range for voltage values where you can choose the voltage range to limit the voltage values (B22, B23, and B25), the range of voltages are ± 2.5 V, ± 5 V, ± 10 V, and ± 16 V. Each range has 16-bit precision. The set range setting is also restricting the set limit setting, so the limit cannot exceed the range.

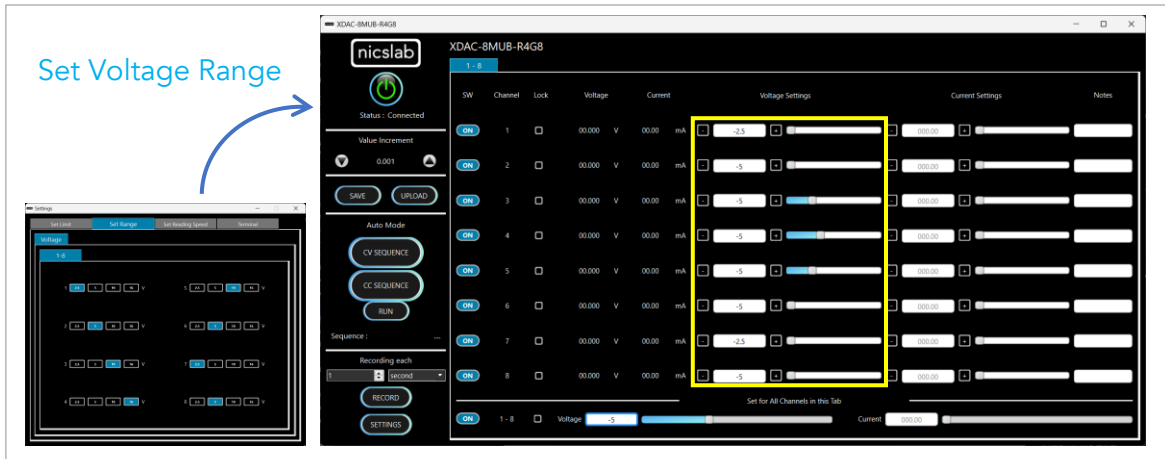

- Set the reading speed to adjust different speeds for reading voltage and current. The speed is based on averaging the number of sample output values. There are three options which are Fast, Medium, and Slow. Faster options can make conversion time smaller but the results noisier.

Reading Speed



- Set threshold for voltage and current measurement value (B24 & B25). The range is similar to set limit which is 0 – 34 for voltage and 0 – 300 for current. User can set the upper and lower bound value. User can turn on or off this feature at will by toggling the checkbox beside each channel number. If the measured value reached or exceeds the threshold value, the hardware will adjust the value and a warning sign will appear in the setting window. After the threshold is triggered and the channel is turned off, you need to re-enable the threshold feature and re-enter the control value for the channel that turned off. This feature is useful for voltage or current sensitive equipment that cannot exceed a certain value.

Set Threshold (OFF)

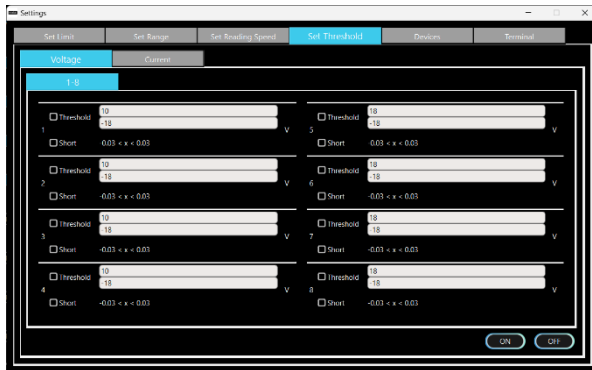

Set Threshold (ON and Triggered)



Measured Value at > 10 V

In the mainwindow, each channel that have threshold feature triggered is also turned green:

SW	Channel	Lock	Voltage	Current	Voltage Settings	Current Settings	Notes
ON	1 open	<input type="checkbox"/>	10.053 V	005.04 mA	10	5	
ON	2 open	<input type="checkbox"/>	10.099 V	005.02 mA	10	5	
ON	3 open	<input type="checkbox"/>	10.074 V	004.98 mA	10	5	
ON	4 open	<input type="checkbox"/>	09.925 V	005.03 mA	10	5	
OFF	5	<input type="checkbox"/>	00.000 V	000.00 mA	0	0	
OFF	6	<input type="checkbox"/>	00.000 V	000.00 mA			
OFF	7	<input type="checkbox"/>	00.000 V	000.00 mA			
OFF	8	<input type="checkbox"/>	00.000 V	000.00 mA			

Important note: Voltage and Current threshold configuration only available on Firmware version 4.1.1.1 and up

- Set shorted for voltage and current measurement value (B24 & B25). The trigger condition is when voltage value on a channel is between -0.03 to 0.03 and the current value is between -5 to 5. User can turn on or off this feature at will by toggling the checkbox beside each channel number. If the measured value is inside the range of shorted value, a warning sign will appear in the setting window. After the shorted is triggered and the channel is turned off, you need to re-enable the shorted feature and re-enter the control value for the channel that turned off. This feature is useful for voltage or current sensitive equipment that cannot last long in a shorted situation.

Set Shorted (OFF)



Set Shorted (ON and Triggered)

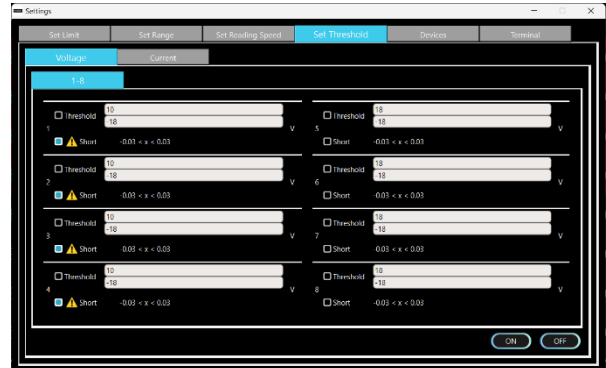

Measured Value at 0 V and 7.5 mA

In the mainwindow, each channel that have shorted feature triggered is also turned red:

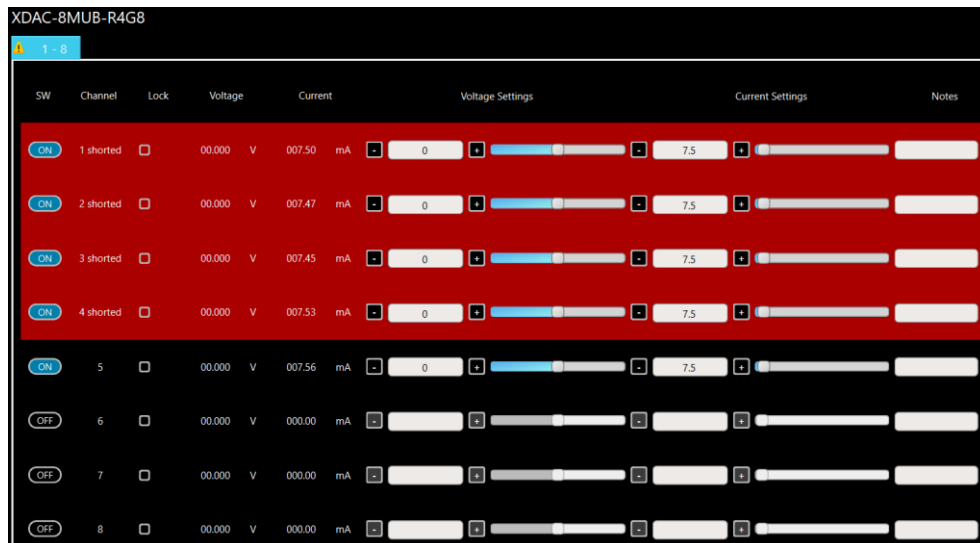

Important note: Voltage and Current shorted configuration only available on Firmware version 4.1.1.1 and up

- Devices to connect additional devices that can be controlled using one GUI. This feature is useful when you have multiple XDACs and need to connect them using one GUI. You can also disconnect or shutdown a particular device. **This feature is an optional addition to your XDAC, so contact our team beforehand.**

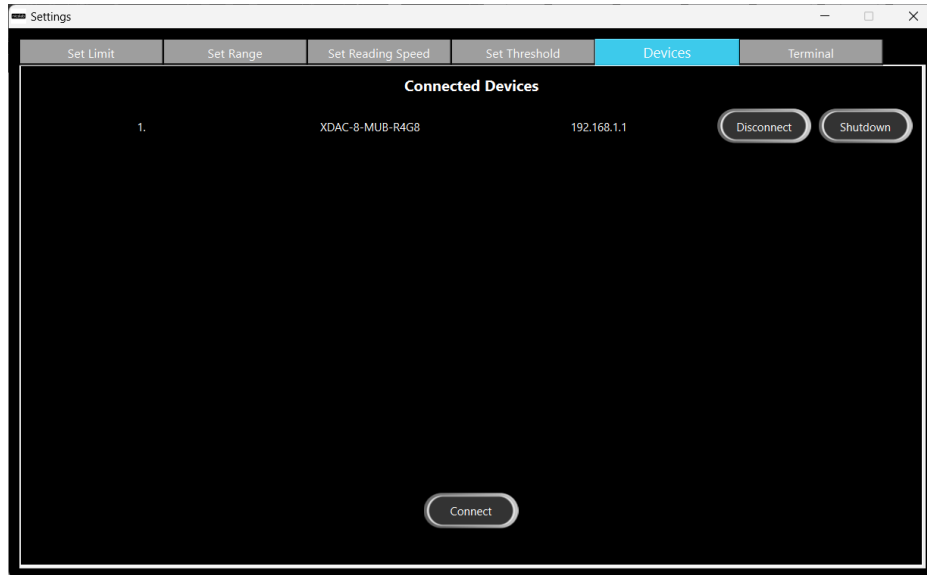

- Terminal to read the input from software to hardware and the corresponding hardware response. This feature is useful to find problems with the hardware or software.

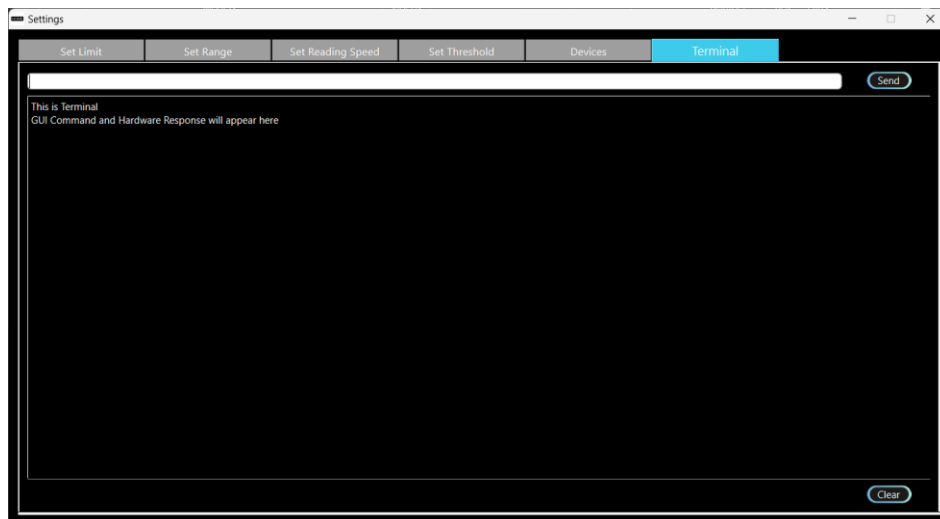

4. Operating XDAC through the SCPI command

This section set guidelines to help you develop a program for any language that suits you best. As an example, we give the Python example.

Python Installation (Example)

Please follow the steps below for dynamic programming using the SCPI command through Python via TCP/IP.

The following Python version and packages need to be installed:

1. Python 2.7 or Python 3.X (download and install the latest version from www.python.org). *Tested with Python 3.9.
2. PyCharm 2017.3.4 or the latest version (download and install the latest version from <https://www.jetbrains.com/pycharm/>)

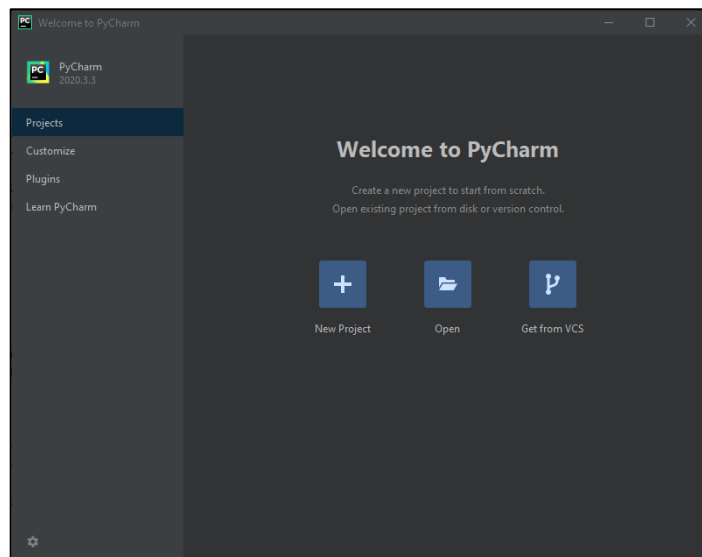

Run Python Code (Example)

To run the Python code please follow the steps below:

1. Open PyCharm software and open file example (e.g XDAC-8MUB-R4G8.py)

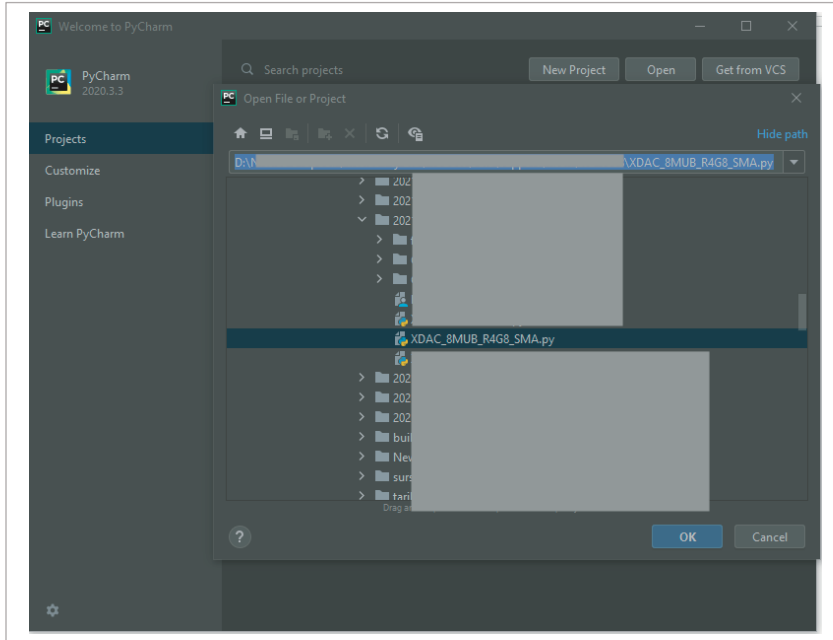

2. Configure the Python interpreter (see figure below) by clicking Configure Python Interpreter link on the drop-down menu, or in File >> Settings >> Project Interpreter.

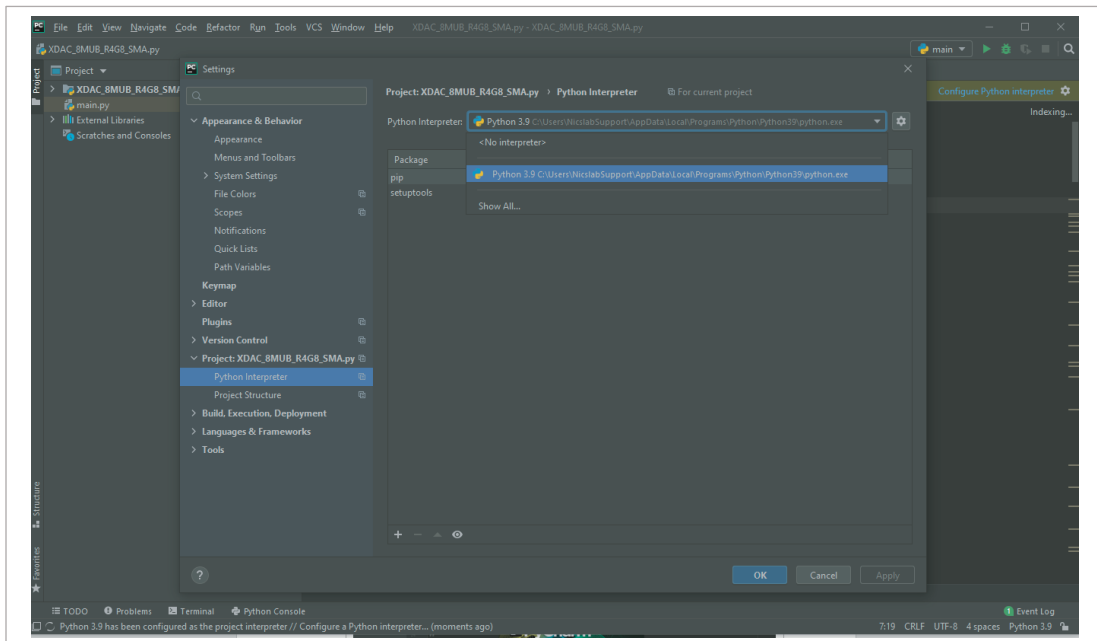

3. Install additional packages, for example, enum34, by:
 - A. Click '+' button
 - B. Search and choosing enum34
 - C. Install all the packages.

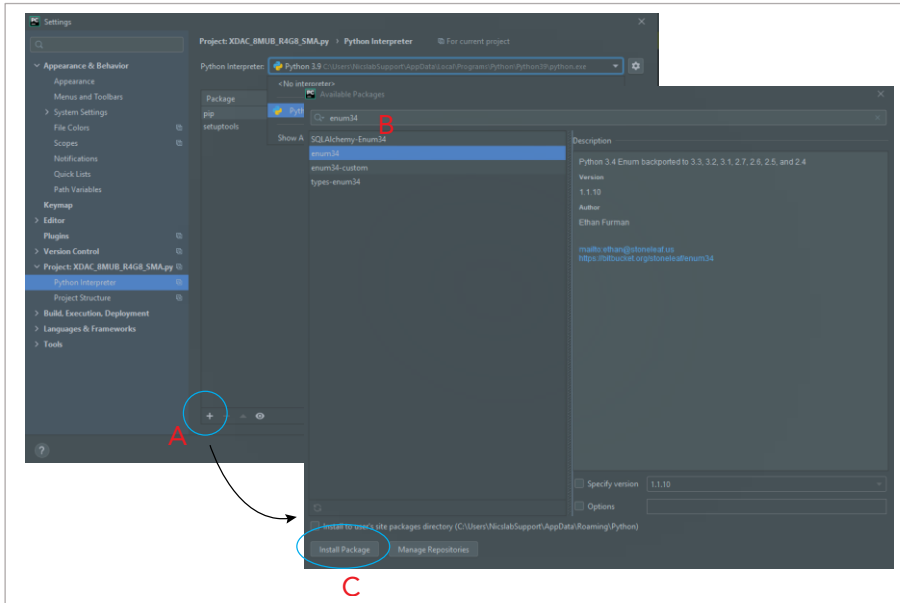

4. The packages for the Python Interpreter are listed in the green rectangle.

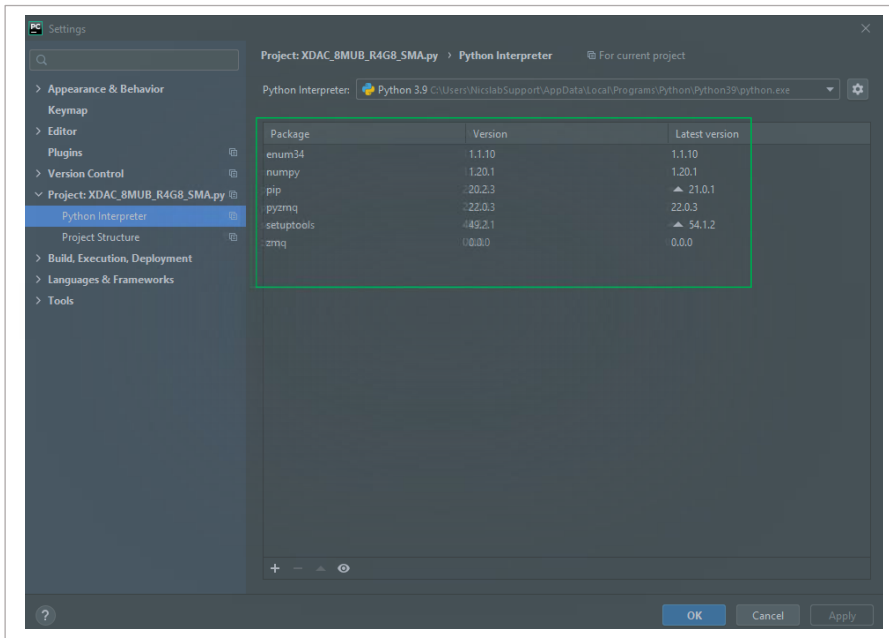

5. Select Python Configuration and choose the file name.
6. Run the file by clicking the green arrow button on the top right corner to test the XDAC (Please refer to the code and SCPI commands references).

Python Function (Example)

1. Input IP Address

```
XDAC_IP = "169.254.xx.xx"
```

2. Unlock and Lock XDAC

```
print (unlock ("XDACkey"))
```

```
lock ()
```

note: You must unlock your XDAC first before you can use

3. Set XDAC voltage range for all channels and measurement mode

```
setXDAC (voltRange, voltReadingMode, currentReadingMode )
```

voltRange (int list): List for all channels range

voltReadingMode (string): "FAST" or "MEDIUM" or "SLOW"

currentReadingMode (string): "FAST" or "MEDIUM" or "SLOW"

Example:

```
AllRValues = [5, 5, 6, 7, 5, 5, 7, 4]
```

```
setXDAC (AllRValues, "FAST", "SLOW")
```

4. Set Voltage for single channel

```
setChannelVoltage (channel, voltageVal)
```

channel (int): channel number

voltageVal (float): -16 - +16 V

Example:

```
SetChannelVoltage (1, 15)
```

```
#Set voltage to 15 V in channel 1
```

5. Set Current for single channel

```
setChannelCurrent (channel, currentVal)
```

channel (int): channel number

currentVal (float): 5 - 500 mA

Example:

```
SetChannelCurrent(1, 200)
```

#Set current to 200 mA in channel 1

6. Set Voltage Range for single channel

```
setChannelVoltageRange(channel, range)
```

channel (int): channel number

range (int): 4 - 7

Description:

4: -2.5 – 2.5 V

5: -5 – 5 V

6: -10 – 10 V

7: -16 – 16 V

7. Set for all channels

```
setVoltageAllChannels(AllVValues)
```

AllVValues (float array): voltage values in an array (V)

```
setCurrentAllChannels(AllCValues)
```

AllCValues (float array): current values in an array (mA)

```
setRangeAllChannels(AllRValues)
```

AllRValues (float array): range values in an array

Example:

```
AllCValues = [100, 150, 100, 50, 200, 10, 10]
```

```
AllVValues = [20.1, 2.5, 13.0, 4, 5, 10.5, 9.5, 22]
```

```
AllRValues = [5, 5, 6, 7, 5, 5, 7, 4]
```

```
setRangeAllChannels(AllRValues)
```

```
setVoltageAllChannels(AllVValues)
```

```
setCurrentAllChannels(AllCValues)
```

8. Set OFF for single channel

```
setOff(channel)
```

channel (int): channel number

9. Set averaging method and count for measurement

```
setReadingModeVoltage(mode, count)
```

```
setReadingModeCurrent(mode, count)
```

count (int): number of measurements to be averaged

mode (string): "MOVING" or "REPEAT"

Example:

```
mode: "MOVING", count: 5
```

```
#n : read #n from sensor
```

```
[#1, #2, #3, #4, #5 ] ⇒ averaged ⇒ reading #1
```

```
[#2, #3, #4, #5, #6 ] ⇒ averaged ⇒ reading #2
```

```
mode: "REPEAT", count: 5
```

```
#n : read #n from sensor
```

```
[#1, #2, #3, #4, #5 ] ⇒ averaged ⇒ reading #1
```

```
[#6, #7, #8, #9, #10 ] ⇒ averaged ⇒ reading #2
```

10. Read voltage or current for single channels

```
readSingleChannelVoltage(channel)
```

```
readSingleChannelCurrent(channel)
```

channel (int): channel number

Return value of voltage or current in one channel

11. Read measurement values for all channels

```
readAllChannelVoltage()
```

Return list of voltage from all channels

```
readAllChannelCurrent()
```

Return list of current from all channels

12. Set one channel to run automatically and record it

```
sweepOne(channel, seqValueV, seqValueC, duration)
```

channel (int): channel number

seqValueV: voltage values in an array (V)

seqValueC: current values in an array (mA)

duration (int): duration in seconds

13. Shutdown

```
shutdown()
```

SCPI Commands

The XDAC can be controlled using Standard Commands for Programmable Instruments (SCPI). To initialize the SCPI commands, you need to import ZMQ library. Then you must use Req-Rep mode in port "5555". After that you can type your commands and send it to the XDAC. You can see the example below:

```
import zmq

# Change with XDAC IP Address
XDAC_IP = "192.168. [REDACTED]"

# Connect to Req Server on XDAC via ZMQ
context = zmq.Context()
req_socket = context.socket(zmq.REQ)
req_socket.connect("tcp://%s:5555" % XDAC_IP)
```

Description: Unlock XDAC by XDAC Key

Format:

```
GETINFO:KEY
```

Example 1: Unlock XDAC with XDAC Key : nicslab.

```
GETINFO:nicslab
```

Description: Lock XDAC

Format:

```
LOCK
```

Description: Set output voltage for single channel

Format:

SETV:CHANNEL:VOLT

Example 1: Set the output of channel 1 to 16 V.

SETV:1:16

Example 2: Set the output of channel 3 to -12.5 V.

SETV:3:-12.5

Description: Set output current for single channel

Format:

SETC:CHANNEL:CURRENT

Example 1: Set the output of channel 1 to 500 mA.

SETC:1:500

Example 2: Set the output of channel 3 to 50 mA.

SETC:3:50

Description: Set output voltage range for single channel

Format:

SETR:CHANNEL:RANGE

Range (int): 4 - 7

4 = -2.5 - 2.5 V

5 = -5 - 5 V

6 = -10 - 10 V

7 = -16 - 16 V

Example 1: Set the voltage range of channel 1 from -16 to 16 V.

SETR:1:7

Description: Read the voltage of a single channel

Format:

MEASV:CHANNEL

Example 1: Get the voltage output of channel 1

MEASV:1

Description: Read the current of a single channel

Format:

MEASC:CHANNEL

Example 1: Get the current output of channel 1

MEASC:1

Description: set averaging mode and count of voltage measurement

Format:

MEASV:MODE:COUNT

Example 1: Set voltage measurement averaging to repeat mode and count 100.

MEASV:REPEAT:100

Example 2: Set voltage measurement averaging to moving mode and count 5.

MEASV:MOVING:5

Description: set averaging mode and count of current measurement

Format:

MEASC:MODE:COUNT

Example 1: Set current measurement averaging to repeat mode and count 100.

MEASC:REPEAT:100

Example 2: Set current measurement averaging to moving mode and count 5.

MEASC:MOVING:5

Description: Set zero voltage for single channel

Format:

ZERO:CHANNEL

Example: Set zero of channel 1

ZERO:1

Description: Shutdown System

Format:

EXIT

5. System Shutdown

This section describes how to shut down the XDAC-8MUB-R4G8.

In the case of using GUI, the steps are as follows:

1. Set OFF all the channels in the GUI.
2. Press the ON/OFF Button in GUI (B1, Figure 4). It will change the color of the button from green to grey.
3. Close the GUI application
4. Press the SYSOFF Button (A4, Figure 3) (it will soft shut down the program inside the XDAC-8MUB-R4G8).
5. Press the power switch (A1, Figure 3).
6. Turn off or disconnect the DC Power Supply.

In the case of using SCPI Command, the steps are as follows:

1. Use `setOFF(channel)` function to set off the channel used before.
2. Use `lock()` and `shutdown()` functions to soft shut down the program inside the XDAC-8MUB-R4G8.
3. Press the power switch (A1, Figure 3).
4. Turn off or disconnect the DC Power Supply.

NOTE: Once the soft shutdown occurred, the **Green** led will be turned off, and XDAC-8MUB-R4G8 cannot directly be used again, since the system is not ready (refers to Hardware Installation). To use XDAC-8MUB-R4G8 after a soft shutdown occurred, restart the power from DC Power Supply (using button A8 or unplug and plug the DC Power Supply).

6. Troubleshooting

Please use the following guidelines to identify a particular problem. If the solution does not rectify the problem, contact us at support@nicslab.com.

Table 7. Troubleshooting

Problem	Cause	Solution
Failed to connect at GUI	The DC power supply is OFF	Turn ON the DC power supply and switch ON the power.
Failed to connect at GUI	The power switch is OFF	Switch ON the power.
Failed to connect at GUI	No Green light (XDAC system is not ready)	Restart the system by pressing the 'Reset' button and wait until the Green light is ON.
Failed to connect at GUI	No Yellow light (no data transfer)	Restart the GUI.
The Yellow light is off when the software is active or the software freezes	Initialization failed	Restart the software, or unplug - plug the USB/Ethernet connector, or Press the Reset button.
No channel output detected at the device under test	Connection failed	Check the metal pad checkpoint to the intended channel.
Unable to upload the file	File format problem	Make sure the file format is .csv
No value after uploading the file	File problem	Check the file content and make sure there is no blank space on each row.
Unable to use the Auto Mode feature	File format problem	Check file format. It should be a CSV file. Check content format.

7. Warranty

Nicslab warrants the hardware and software designed by Nicslab to work accordingly, fulfilling the highest standard of a quality product. Nicslab is not liable for consequential or incidental damages or for errors in subject to misuse, neglect, accident, modification, use in critical operation, or has been soldered or altered in any way outside stated by us or for unauthorized maintenance.

Nicslab retains to change the material and technical data of this manual at any time without notice, in future editions.

Please do not hesitate to contact us at support@nicslab.com if you would like to have more information on the warranty or return and refund policy.

8. Compliance

This product complies with the requirements of the European Union's *Conformite Europeenne* (CE) and Restriction of Hazardous Substances in Electrical and Electronic Equipment (RoHS) Directive 2015/863 (RoHS3). The certificates can be accessed [here](#).

9. Contact

United States

Nicslab, Ops Inc

228 Hamilton Avenue, 3rd Floor, Palo Alto

Silicon Valley, CA, 94301

Phone: +1 (650) 521-9982

Email: support@nicslab.com

Website: www.nicslab.com.

Indonesia

PT. Nicslab Global Industri

Wisma Monex 9th floor

Jl. Asia Afrika No. 133-132, Bandung West Java 40112

Phone: +62 22 8602 6854

Email: nicslab.id@nicslab.com

Book a meeting [here](#).