

1 – Description

Thanks to its flexible bulk grating technology, KYLIA is able to propose the most complete DWDM mux/demux product range :

- up to 48 channel
- any spacing from 6.25 GHz till 400 GHz
- S+C+L+U band (1460nm to 1675nm) or around 1310nm
- Flat Top shape or specific shape option
- PM option

All KYLIA mux/demux products are passively athermal.

Since 1998, KYLIA MICS product is deployed on the field by system vendors, for metro, long haul and submarine networks.

MICS is qualified to TELCORDIA 1209 and TELCORDIA 1221.

Ordering Information:



800 Village Walk #316
Guilford, CT 06437
Ph: 203-401-8093

Email orders to: sales@xsoptix.com
Fax orders to: 800-878-7282



MICS 100x55x16mm



MICS 130x65x19.5mm



MICS PM TFF 36x22x9m



MICS 175x115x26.5mm

2 – Technology

KYLIA's MICS are made using our proprietary Bulk Grating Technology (BGT). This method uses a combination of individual micro-optical elements arranged in a free-space architecture. The grating itself is a diffractive element that enables angular separations of the wavelengths, while lenses and prisms allow component designers to couple light into and out of fibers.

BGT lends itself to the manufacture of naturally athermal devices. Since the light propagation is through inert gas, the thermal drifts are very low and can reach a drift level of less than 1 pm/°C.

Thanks to the versatility of our technology, we are able to propose to most complete range of DWDM Mux/Demux, with spacing from 6.25GHz till 400GHz.

3 – Absolute maximum ratings

Parameter	Symbol	Min	Typ.	Max	Unit	Remarks/Conditions
Maximal optical input power ¹	OpIn			300	mW	CW
Storage temperature range	STR	-40		85	°C	
Humidity	RH	5		85	%	Non condensing
Fiber bend radius		20			mm	

4 – Operating conditions

Parameter	Symbol	Min	Typ.	Max	Unit	Remarks/Conditions
Operating wavelength	OWR	1460		1675	nm	
Operating temperature range	OTR	-5		70	°C	

5 – Specifications

5.1 – Common specifications

Parameter	Symbol	Min	Typ.	Max	Unit	Remarks/Conditions
Passband	PB	± spacing / 8			GHz	PB is the passband over which other parameters are specified and measured.
Optical Return Loss	ORL	30	40		dB	
Polarization mode dispersion	PMD			0.2		
Directivity		50				
Chromatic Dispersion	CD	-10		+10	ps/nm	
Fiber type for SM		SMF-28				
Fiber type for PM		PM PANDA				
Loose tube diameter			900		µm	
Fiber Pigtail Length		0.9	1.0	1.1		
IL thermal stability over OTR		-0.5		0.5	dB	
Wavelength thermal stability				1.0	pm/°C	For 100GHz spacing MICS

¹ KYLIA proposes a **HIGH POWER option**. The maximum input power depends on MICS characteristics.

5.2 – Specification definitions

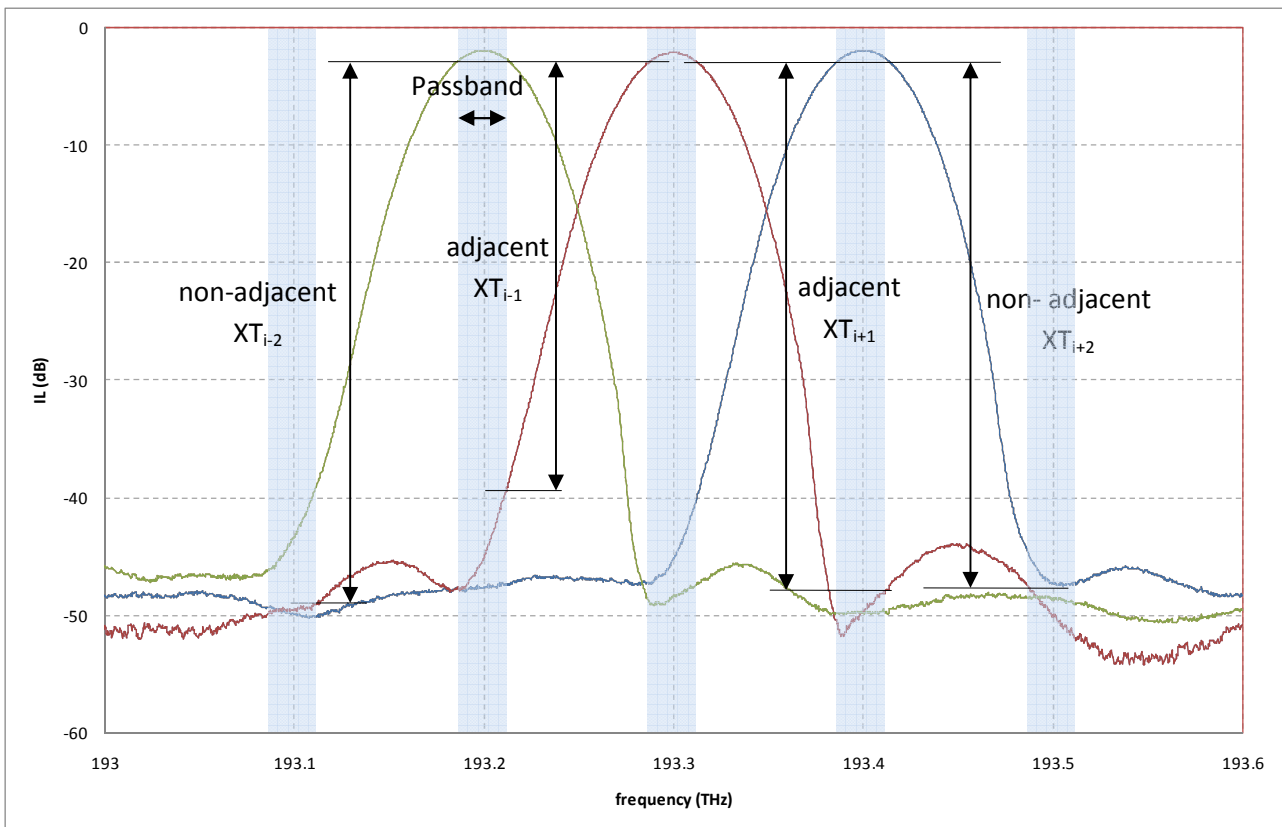
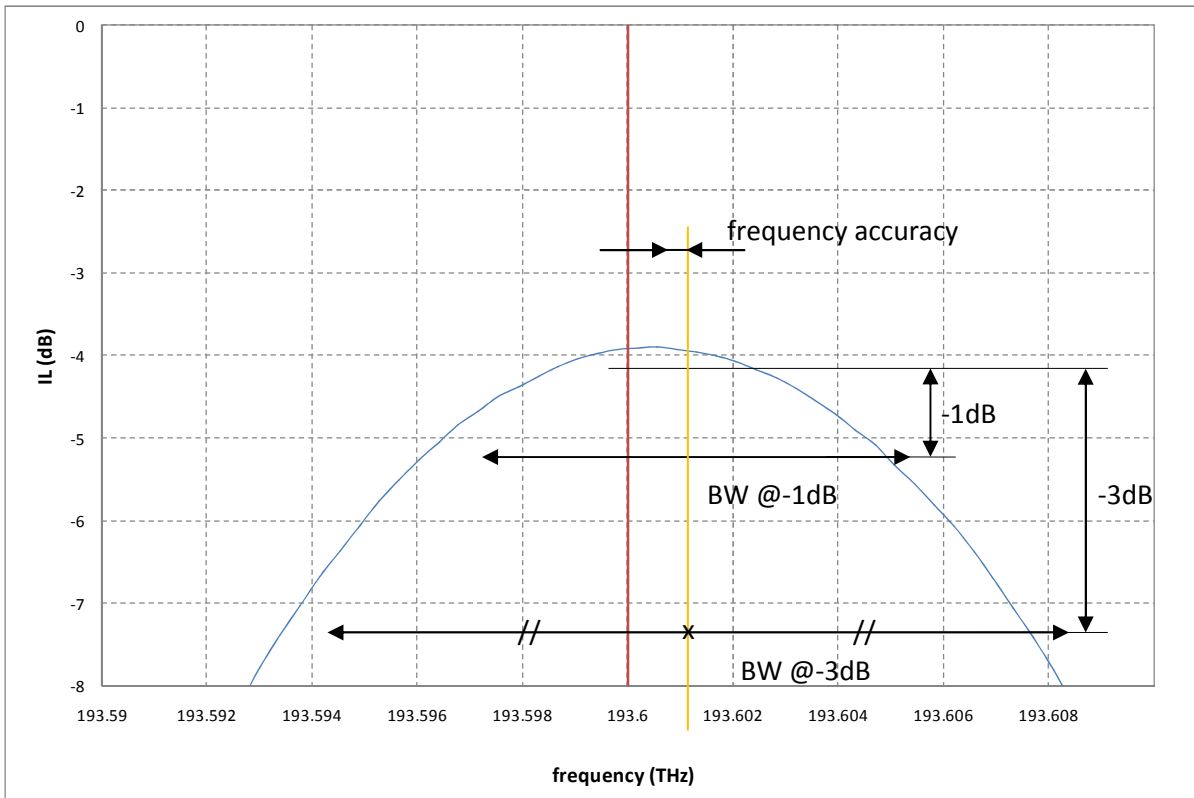

Adjacent crosstalk : $XT_i = \min (XT_{i-1} ; XT_{i+1})$

Non-adjacent crosstalk : $NAdj.XT_i = \min_{j \neq i} XT_j$

Cumulative crosstalk : $Cum.XT_i = \sum_{j=0}^n XT_{j \neq i}$

5.3 – Gaussian shape MICS specification table vs spacing and channel count

parameter	unit	< 16 channel										< 48 channel									
		6.25	12.5	25	33.33	37.5	50	100	200	400	6.25	12.5	25	33.33	37.5	50	100	200	400		
spacing	GHz	6.25	12.5	25	33.33	37.5	50	100	200	400	6.25	12.5	25	33.33	37.5	50	100	200	400		
Insertion Loss	dB	7.5	6.5	5.0	5.0	5.0	4.0	3.5	4.0	5.5	8.5	7.5	6.0	6.0	6.0	5.0	5.0	6.0	6.5		
IL uniformity	dB	1.0	1.0	1.0	1.0	1.0	1.0	1.0	1.0	1.0	1.5	1.5	1.5	1.5	1.5	1.5	1.5	1.5	1.5		
Polarization Dependent Loss	dB	0.3	0.3	0.3	0.3	0.3	0.3	0.3	0.3	0.3	0.4	0.4	0.4	0.4	0.4	0.4	0.4	0.4	0.4		
Channel center accuracy	GHz	0.75	1.25	2.50	2.50	2.50	2.50	3.75	6.75	7.50	1.00	1.75	3.12	3.12	3.12	3.12	6.25	7.50	8.50		
Bandwidth @-1dB	GHz	1.75	3.5	7	9.3	10.5	14	28	56	112	1.75	3.5	7	9.3	10.5	14	28	56	112		
Bandwidth @-3dB	GHz	3	6	12	16	18	24	48	96	192	3	6	12	16	18	24	48	96	192		
Adjacent crosstalk	dB	28	28	28	28	28	30	30	30	30	25	25	25	25	25	30	30	30	30		
Non-adjacent crosstalk	dB	40	40	40	40	40	40	40	40	40	40	40	40	40	40	40	40	40	40		
Cumulative crosstalk	dB	24	24	24	24	24	25	25	25	25	22	22	22	22	22	22	22	22	22		
Packaging	dB	C	B	A	A	A	A	A	A	A	C	B	B	B	A	A	A	B	B		

packaging	A	B	C
dimensions (mm)	100 x 55 x 16	130 x 65 x 19.5	175 x 115 x 26.5

6 – Flat Top shape and specific shape options

KYLIA provides Flat Top shape MUX/DEMUX. On our Flat Top MICS, the BW @-1dB and BW @-3dB are wider than for a Gaussian shape MUX/DEMUX but the IL are higher.

We also propose customized shape according to customer requirement, for instance :

- shape “between” Flat Top and Gaussian in order to provide the best compromise between BW and IL
- high crosstalk (40dB guaranteed)
- Gaussian shape with wider BW (then lower crosstalk)

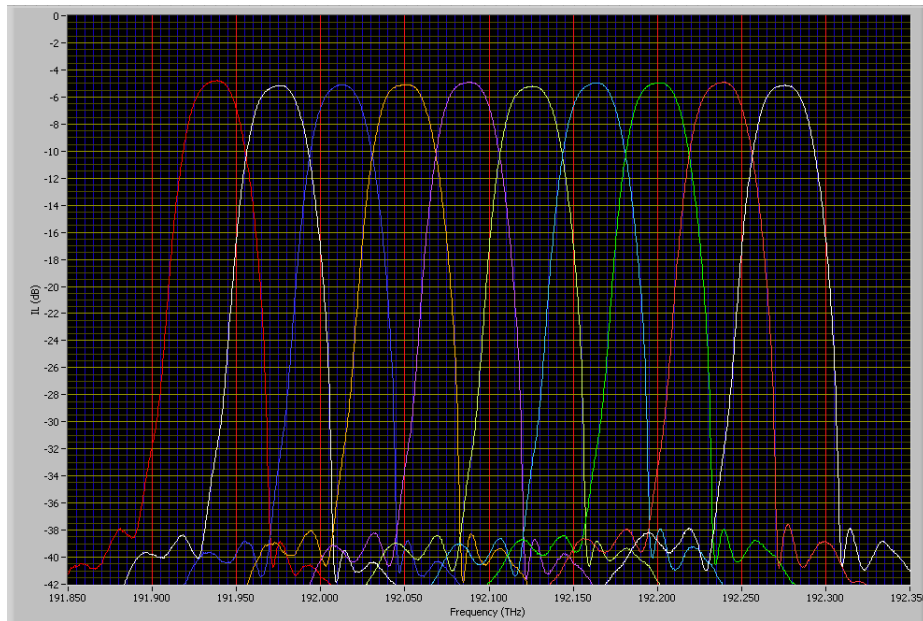

Mux/Demux 37.5GHz spacing with BW @-1dB > 19GHz

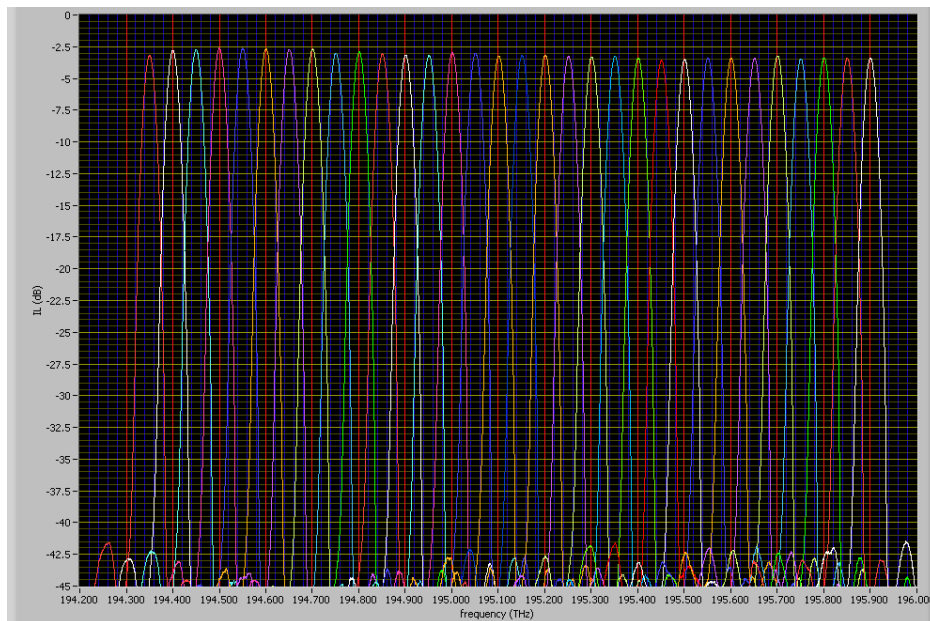

Mux/Demux 50GHz spacing with XT > 38dB

7 – PM option / mini-size PM MICS

7.1 – Bulk grating technology PM mux/demux

PM option is available for each product of KYLIA mux/demux range. PM mics exhibits the highest PER on the market (19dB).

Customers can choose between two configurations :

19dB PER configuration

Using a polarization filter, KYLIA guarantees a PER > 19dB.

In the configuration, the mux/demux can only be used with input beam polarization oriented along the slow axis.

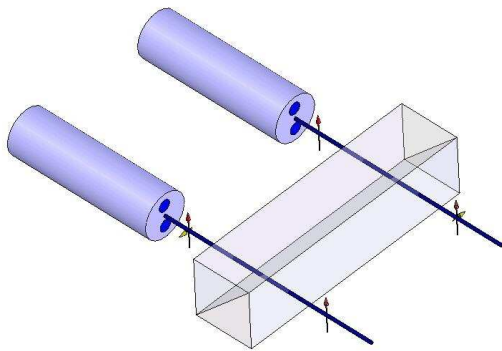

15dB PER configuration

Without polarization filter, KYLIA guaranteed a PER > 15dB.

In the configuration, the mux/demux can be used with input beam polarization oriented along both axis, or even as a SM mux/demux.

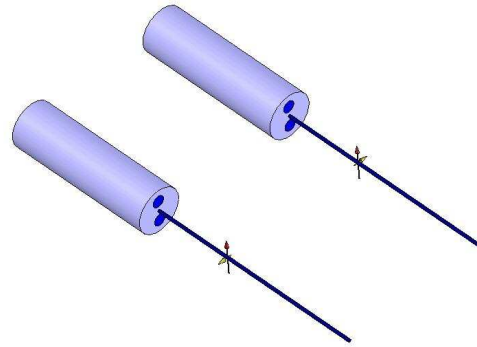

7.2 – Thin Film Filters PM mux/demux

KYLIA also propose a DWDM PM mux/demux based on 100GHz or 200GHz TFF (Thin Film Filters) integrated into a mini-size packaging.

Parameter		Specification	Unit
Insertion Loss		< 2	dB
IL uniformity		< 0.6	dB
Channel Center accuracy	100 GHz spacing	± 8	GHz
	200 GHz spacing	± 16	GHz
BW @-0.5dB	100 GHz spacing	> 50	GHz
	200 GHz spacing	> 100	GHz
Adjacent CrossTalk		> 25	dB
Non-Adjacent CrossTalk		> 30	dB
Cumulative CrossTalk		> 22	dB
PER		> 19	dB

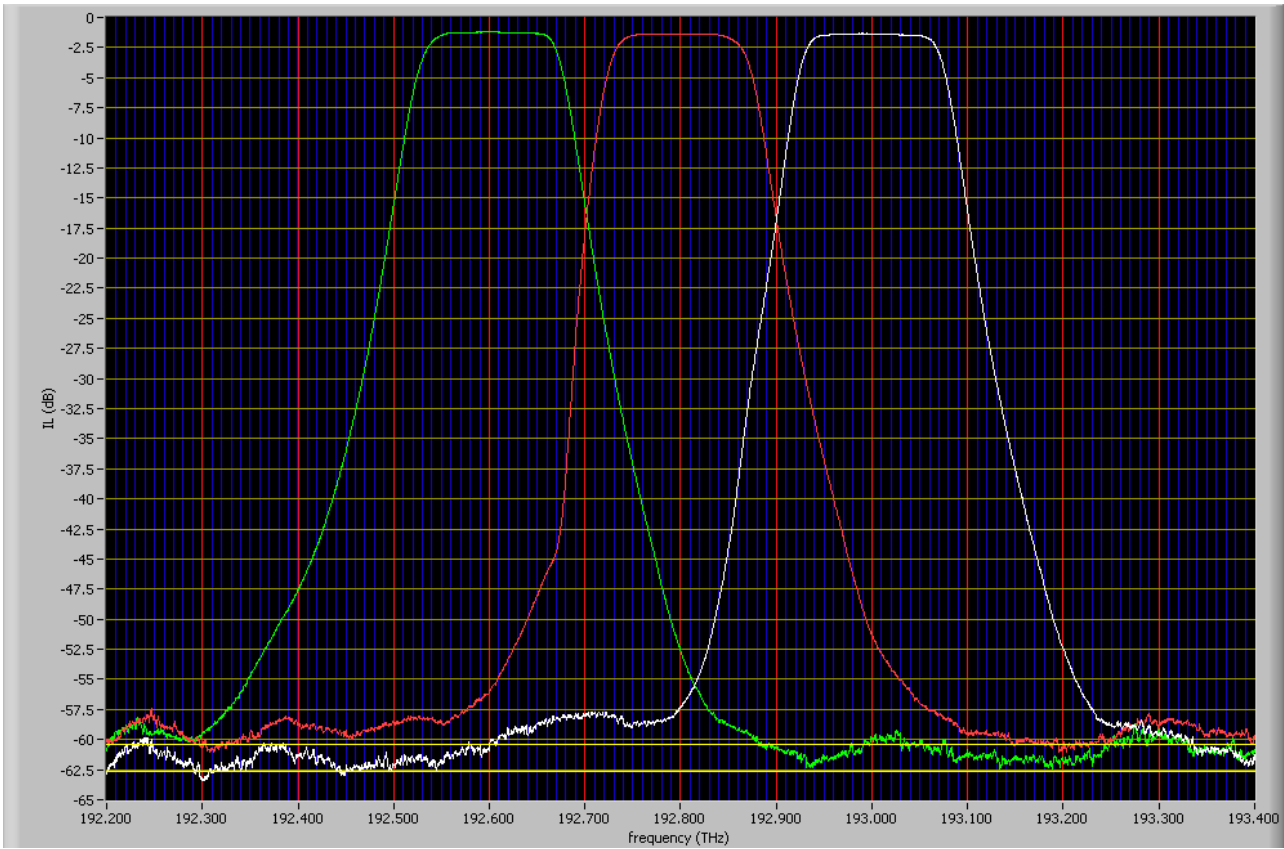

PM Mux/Demux 200GHz spacing based on TFF

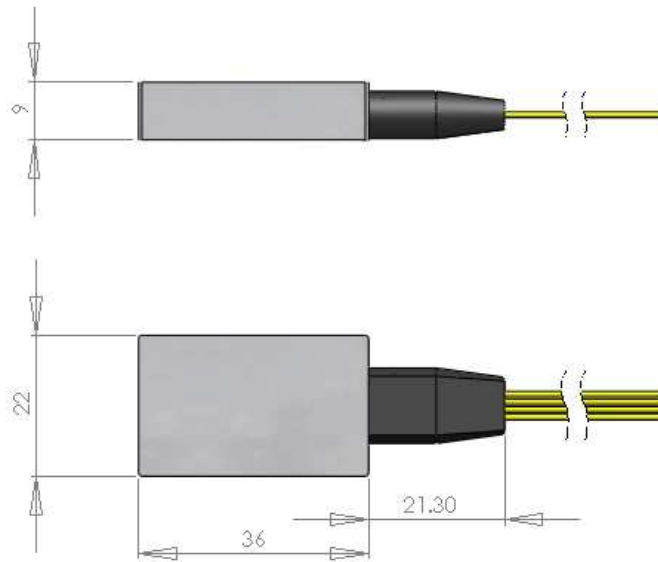

3-channel PM Mux/Demux based on TFF packaging

8 – Package layout

Depending on the MICS parameters (channel count, spacing), 3 packaging size are provided for the KYLIA's bulk gratings mux/demux.

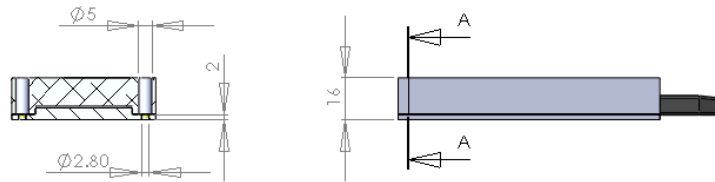

COUPE A-A

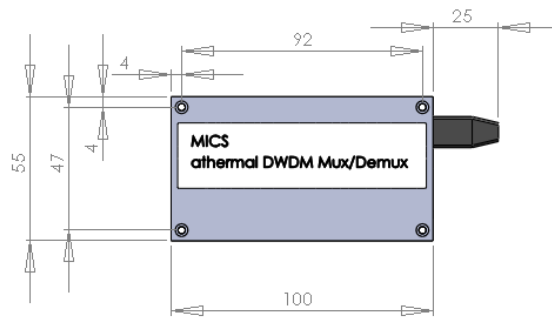

Packaging drawing A : MICS 100x55x16mm

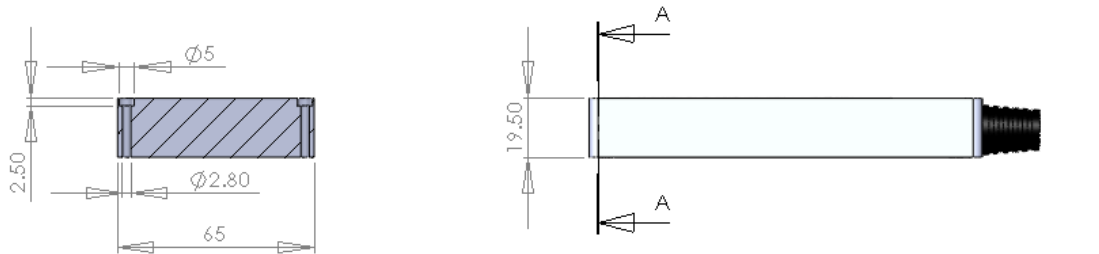

COUPE A-A

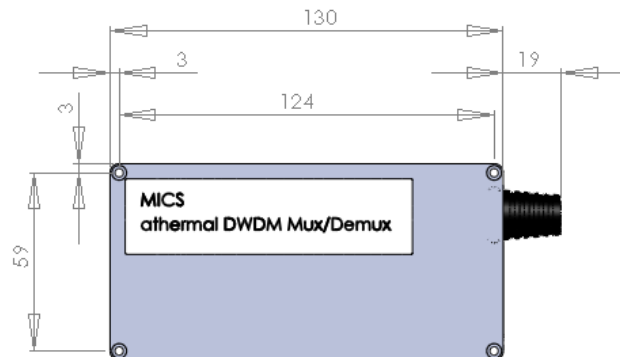

Packaging drawing B : MICS 130x65x19.5mm

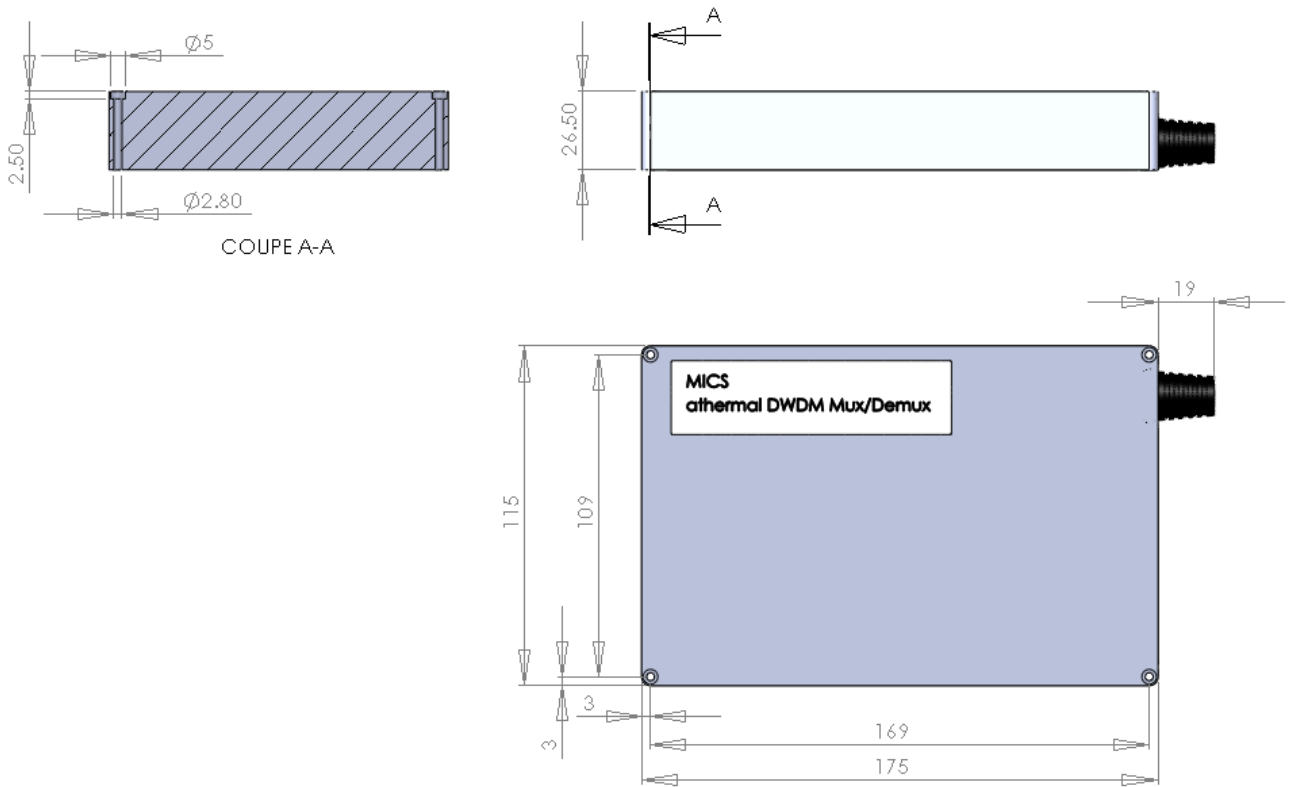

Packaging drawing C : MICS 175x115x26.5mm

9 – Tunable Mux/Demux

Tunable Mux/Demux (TMICS) is the solution for emulating any DWDM Mux/Demux by tuning the spacing and the frequency range.

TMICS is available in manual version (micrometer heads) and motorized version (piloted actuators).

With the motorized option, spacing and frequencies are controlled using a user friendly software for active setup and fast tunability.

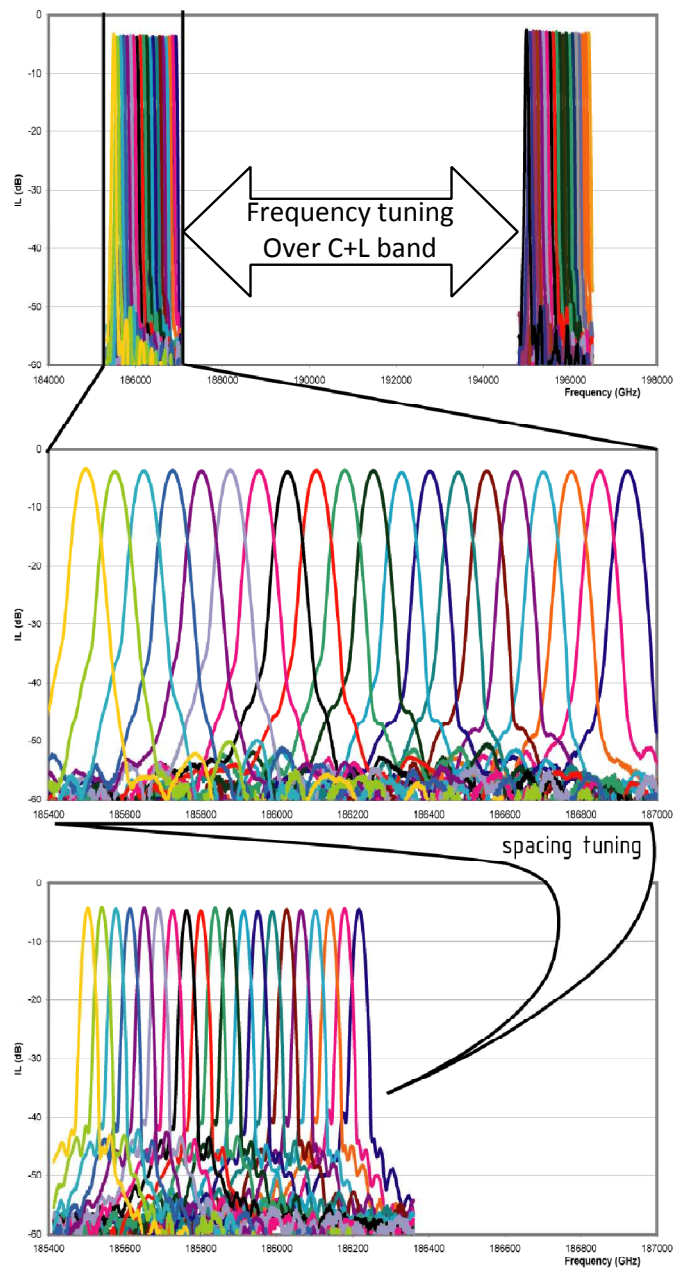

TMICS operation



Parameter		Specification	Unit
Number of channel		< 20	
Frequency tuning range		C+L band	
Insertion losses	12.5GHz to 25GHz spacing	< 6.5	dB
	25GHz to 50GHz spacing	< 6.0	
	50GHz to 100GHz spacing	< 5.0	
Polarization Dependent Loss (PDL)		< 0.5	dB
IL uniformity		< 1.0	dB
BW @-3dB		> spacing x 0.45	GHz
Adjacent CrossTalk		> 25	dB
Cumulative CrossTalk		> 23	dB
Return Loss		> 30	dB
PER (for PM option)		> 15	dB
packaging		19" 2U rack	

TMICS specifications

10 – Connectors

MICS can be proposed with any kind of connectors (FP/UPC, FC/APC, SC/UPC, SC/APC, LC/UPC, LC/APC, E2000/UPC, E2000/APC and MTP).

11 – Revision

date	version	Object
June 2 nd , 2014	MICS V11.0	Added PM TFF MICS, 6.25GHz spacing MICS and 1310nm MICS
February 3 rd , 2015	MICS V11.1	Added TMICS