

Ordering Information:



800 Village Walk #316
Guilford, CT 06437
Ph: 203-401-8093

Email orders to: sales@xsoptix.com
Fax orders to: 800-878-7282

XPOW-8AX-CV-U

SPECIFICATION SHEET AND MANUAL 2024

nicslab

CE RoHS

Version: 3.1

Date: 12 June 2024

Important Notice and Disclaimer:

No part of this document may be reproduced in any form or by any means (including electronic storage and retrieval or translation into a foreign language) without prior agreement and written consent from Nicslab. No responsibility is assumed by Nicslab for its use, nor for any infringements of patents or other rights of third parties that may result from its use. Trademarks and registered trademarks are the property of their respective owners.

This product is designated for skilled user. You are entirely responsible for (1) choosing the appropriate Nicslab products for your operation, (2) designing, validating and testing your operation, (3) ensuring your operation meets applicable standards, and any other safety, security or other requirements.

Copyright © 2023, Nicslab.

Safety Note

Do not operate this product in any manner not specified by Nicslab. Failure to comply with these precautions or with specific warnings or instructions elsewhere in this manual violates safety standards of design, manufacture, and intended use of the instrument. Nicslab assumes no responsibility for any damage caused by mishandling that is beyond normal usage defined in this manual of this product.

Before Applying DC Power Supply

Verify that the DC power supply is good condition and safe to use. It is imperative to use ONE DC power supply as a source power for this product and the input voltage is no more than 36 V, or it can impair this product. Make all connections to the unit before applying power.

Do Not Discard the Instrument Cover

Only authorized personnel from Nicslab should remove the instrument cover.

Do Not Alter the Instrument

Do not put any unauthorized parts or modify the instrument without Nicslab approval and warranty.

Caution

This symbol indicates the hazard of any operating procedure, practice, or the like that, if not correctly performed or adhered to, could result in damage to the product or loss of important data.

Contents

List of Tables	4
List of Figures	4
1. Introduction	5
2. Hardware	7
Specification Conditions	7
Hardware Requirement	7
Box Descriptions	8
XPOW-8AX-CV-U Specifications	11
Hardware Installation	12
3. Software and Graphical User Interface (GUI)	13
Software Requirement	13
Software Installation	13
How to Detect Which COM Is Used (<i>Windows only</i>)	14
Graphical User Interface (GUI)	14
Initializing the GUI	17
Premium Upgrade	17
Constant Voltage (CV) Mode	19
Value Increment Setting	19
Save and Upload	19
Sequence Automation	22
Record	23
Settings	24
4. Operating XPOW through SCPI command	26
Python Installation (Example)	26
Run Python Code (Example)	26
Python Function (Example)	28
SCPI Commands	31
5. System Shutdown	35
6. Troubleshooting	36
7. Warranty	37
8. Compliance	37
9. Contact	37

List of Tables

Table 1. Checklist Items	6
Table 2. Specification Conditions	7
Table 3. DAC Voltage Performance Specification	11
Table 4. Voltage Control Resolution	12
Table 5. Current Value Resolution	12
Table 6. Troubleshooting	36

List of Figures

Figure 1. XPOW-8AX-CV-U System Diagram	6
Figure 2. Product Dimension	8
Figure 3. Front, Back and Top View	9
Figure 4. GUI	15

1. Introduction

Nicslab XPOW-8AX-CV-U is a versatile multichannel source measurement system. The XPOW-8AX-CV-U supports multiple voltage/current sourcing and voltage/current measurement. The system is suitable for sourcing and measuring low-power applications from simple electronic circuits to complex photonic integrated circuits.

The XPOW-8AX-CV-U provides independent 8 channels controlled by Graphical User Interface (GUI) and Standard Commands for Programmable Instruments (SCPI) through Universal Serial Bus (USB) port. The system has one mode: Constant Voltage (CV) ranging from unipolar 0 – 5 Volt, 0 – 10 Volt, 0 – 20 Volt and 0 – 34 Volt (please check your feature selection).

The features for XPOW-8AX-CV-U in details are:

- 16-bits voltage control, see the resolution at Table 4.
- Enable voltage range configuration through software (technology that enables the user to select the output range with software without lose control of the high-resolution feature).
- Flexible output configuration with 16-bit resolution unipolar 0 – 5 V, 0 – 10 V, 0 – 20 V and 0 – 34 V (*Premium Upgrade*).
- Intuitive GUI.
- Measurement time for single channel: 393 ms.
- The maximum power output per channel is 10 watts.
- Real time voltage reading (16-bits resolution = 1.25 mV).
- Real time current reading (16-bits resolution = 5 μ A).
- Save function to create database.
- Upload function to generate the registrable voltage and current pattern.
- Sequence function for continuous voltage and current.
- Short circuits protection.
- SCPI command support (Python, Matlab, C#, and LabVIEW).
- SCPI Library (*Premium Upgrade*).
- Windows, Mac, and Linux support.
- USB port with USB line termination, filtering, and electrostatic discharge (ESD) protection.
- Bi-directional electromagnetic interference (EMI) filtering prevents noise from entering/leaving the system.
- Compliance with IEC61000-4-2 ESD Protection for USB Port.

The XPOW-8AX-CV-U needs to be connected with direct current (DC) Power first then you can plug into the Device-Under-Test (DUT). The voltage/current can be controlled through GUI or SCPI command via USB port.

The system diagram is as follow:

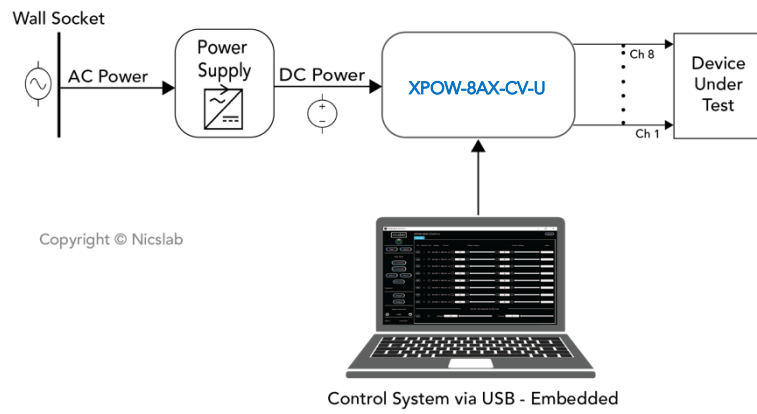

Figure 1. XPOW-8AX-CV-U System Diagram

The package should include the following items:

Table 1. Checklist Items

No	Item	Qty (pc)	Checklist
1	XPOW-8AX-CV-U Box	1	
2	DC power line cord (Red, Black)	2	
3	USB 3.0 type B	1	
4	USB flash disk	1	
5	Inside USB flash disk: a. GUI b. Specification & Manual c. Test Report d. Serial key (Upgrade) e. XPOW key f. Software Library (Premium) g. Comma-separated values (CSV) template (upload, demo sequence)	1	

2. Hardware

Specification Conditions

The operating and measurement conditions are under the following conditions:

Table 2. Specification Conditions

Items	Conditions
Room Temperature	0 ~ 40 °C
Humidity	5 ~ 80 % (No Condensing)
Power Supply Input	DC Supply Max 36 V with effective voltage output range 34 V (potential at red & black DC in). Power supply setting: <ul style="list-style-type: none">- Minimum Voltage 10 V.- Minimum Current 0.5A. Required headroom 1.4 – 2 V.
Waterproof/Dustproof	To be operated under room condition
Calibration period	2 years

Note: To minimize the possibility of overheating the device, it is recommended that the supply voltage value should be the maximum output to be generated + 3 volts. For example, if you have a DUT that needs to be driven by 100mA current with a voltage of 10V, then the recommended power supply setting is 10 + 3 Volts which is 13 Volts.

Hardware Requirement

The requirements for the PC/Laptop to be used for this product installation are:

- Resolution Min. 1024 x 768 pixel
- Hard disk Min. 500 MB of available free space (32-bit and 64-bit operating system)
- USB Port USB 2.0
- RAM Min. 2 GB
- CPU 2.4 GHz or faster

Box Descriptions

Box Descriptions

The box size is 106 mm (W) x 164 mm (L) x 61.1 mm (H), with a weight of 0.7 kg, as shown in the pictures below:

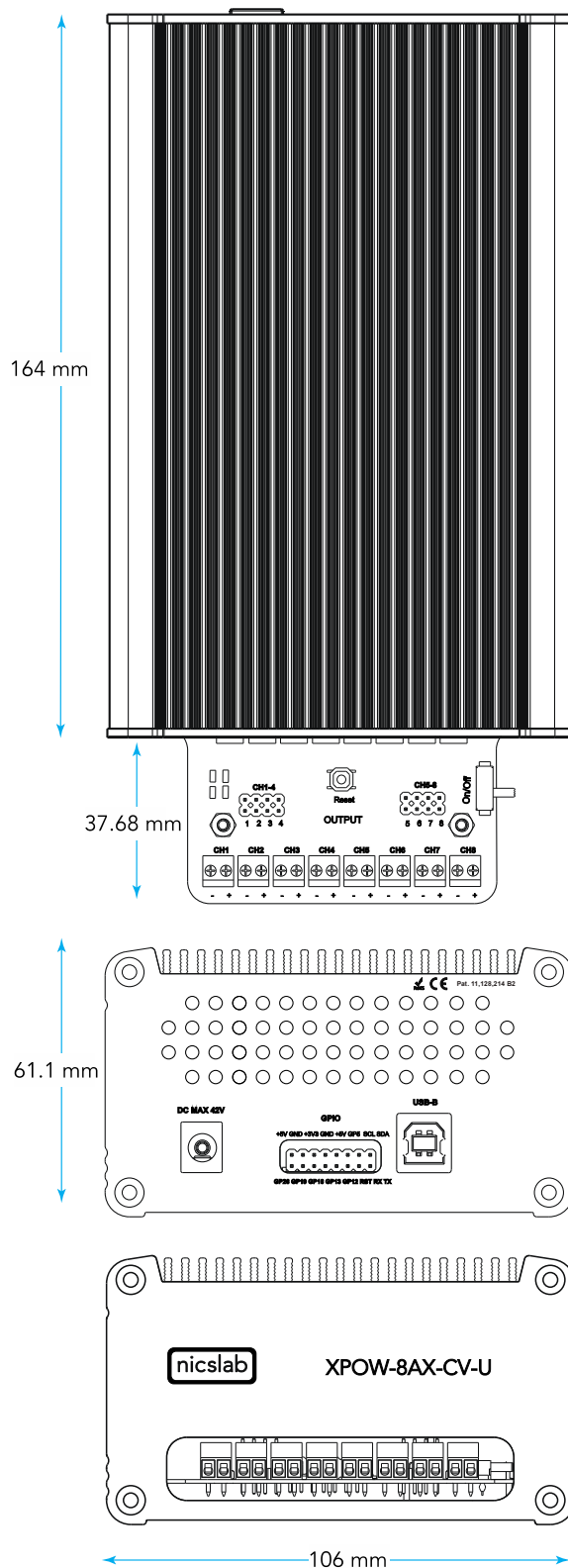

Figure 2. Product Dimension

The details of front, back and top panel of the box are described below:

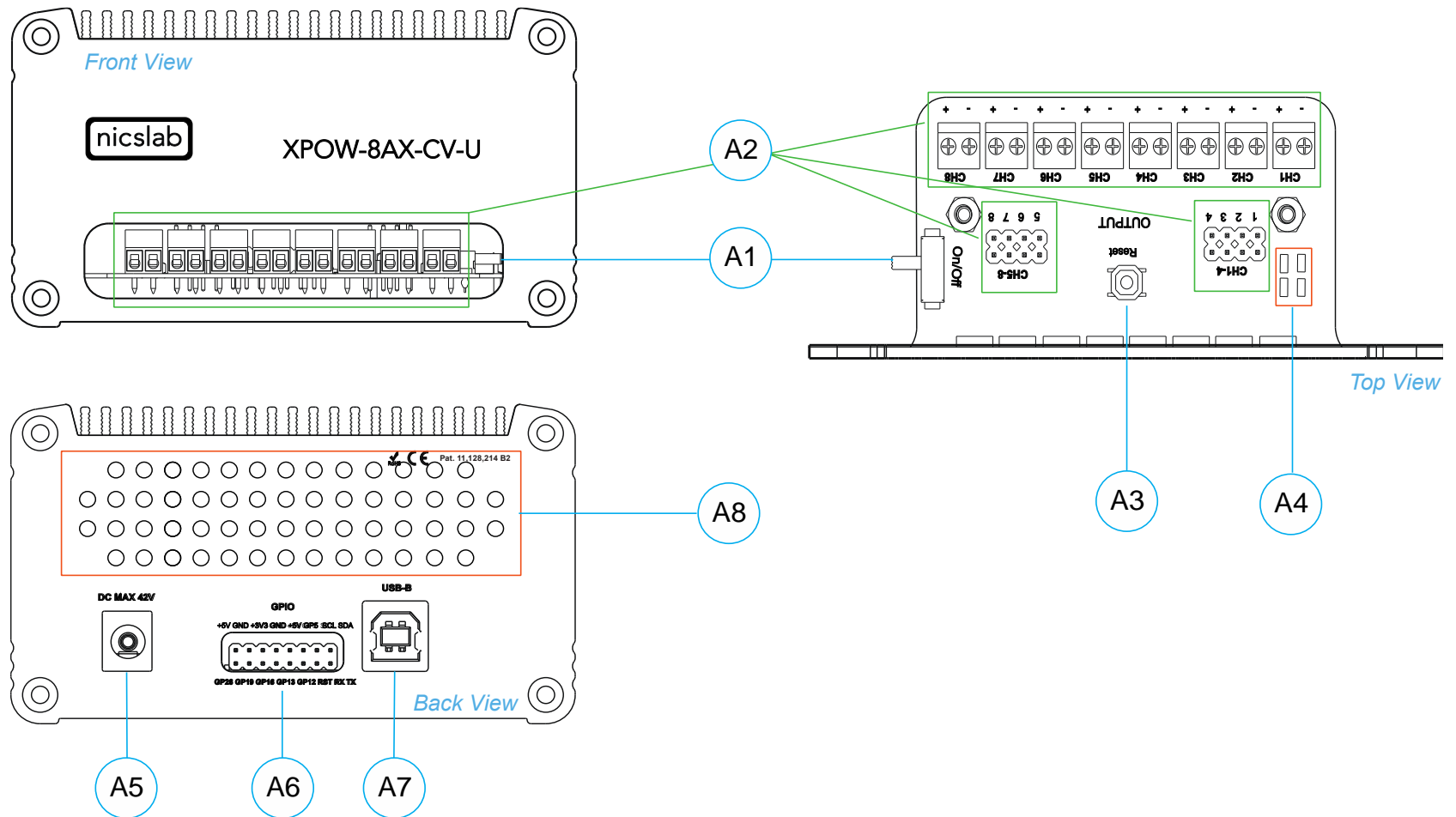

Figure 3. Front, Back and Top View

Note:

A1	Power Switch	Turns the instrument on or off.
A2	Pin Output (8 channels)	To connect to Device Under Test (DUT) using cable.
A3	Reset Button	To reset the system when the initialization failed, system freeze or finding COM port.
A4	Indicator Light	Red and Yellow -> Power Indicator. Green -> Port Connection Indicator. Blue -> Serial Transfer Data Active.
A5	Input DC Max 36 V	Caution Please follow the safety notice on your DC power supply. USE ONLY ONE DC POWER SUPPLY and the input is no more than 36 V. The XPOW will not power up if the current from the power supply is too low (minimum 10 V and 0.5 A). Black cable inserts to negative terminal (0 V) Red cable inserts to positive terminal (36 V)
A6	GPIO	You may use for external control and monitoring direct to microprocessor.
A7	USB Connector	Use the cable type min. USB 2.0.
A8	Airflow	For air circulation inside the box.

XPOW-8AX-CV-U Specifications

The performance specifications of the Digital Analog Converter (DAC) voltage are listed in Table 3 below:

Table 3. DAC Voltage Performance Specification

No	Parameter	Min	Typ	Max	Unit	Test conditions/comments
1	Resolution	16			Bits	
2	Integral nonlinearity (INL)	-1	± 0.5	1	LSB	All ranges, except 0 to 40
3	Differential Nonlinearity (DNL)	-1	± 0.5	1	LSB	Specified 16-bit monotonic
4	Total unadjusted error	-0.1	± 0.01	0.1	%FSR	All ranges
5	Unipolar offset error	-0.03	± 0.015	0.03	%FSR	All unipolar ranges
6	Unipolar zero-code error	0	0.04	0.1	%FSR	All unipolar ranges
7	Full-scale error	-0.2	± 0.075	± 0.2	%FSR	All ranges
8	Gain error	-0.1	± 0.02	0.1	%FSR	All ranges
9	Unipolar offset error drift		±2		ppm of FSR/°C	All unipolar ranges
10	Gain error drift		±2		ppm of FSR/°C	All ranges
11	Output voltage drift over time		5		Ppm of FSR	T _A = 40 °C, Full-scale code, 1900 hours
DYNAMIC PERFORMANCE						
12	Output Voltage Settling Time		12		µs	¼ to ¾ and ¾ to ¼ scale setting time to ± 1 LSB, ±10 V range, R _L = 5 kΩ, C _L = 200 pF
13	Slew Rate		4		V/µs	All range except 0 to 5 V
14	Power-on glitch magnitude		0.3		V	Power-down to active DAC output, Midscale code, R _L = 5 kΩ, C _L = 200 pF
15	Output noise		15		µV p-p	0.1 Hz to 10 Hz, Midscale code, 0 to 5 V range
16	Output noise density		78		nV/√Hz	1 kHz, Midscale code, 0 to 5 V range
17	AC PSRR		1		LSB/V	Midscale code, frequency = 60 Hz, amplitude 200 mVpp superimposed on V _{DD} , V _{CC} or V _{SS}
18	DC PSRR		1		LSB/V	Midscale code, V _{DD} = 5 V, V _{CC} = 20 V ±5 %, V _{SS} = 20 V
19	Code change glitch impulse		4		nV-s	1 LSB change around the major carrier, 0 to 5 V range
20	Channel to Channel AC crosstalk		4		nV-s	0 to 5 V range. Measured channel at midscale. Full-scale swing on all other channels.
21	Channel to Channel DC crosstalk		0.25		LSB	0 to 5 V range. Measured channel at midscale. All other channels at full-scale.
22	Digital feedthrough		1		nV-s	0 to 5 V range, Midscale code, F _{SCLK} = 1 MHz

The voltage control resolution is listed in Table 4 below. The resolution is different for each range. The default range is 40 V (34 V) and can be adjusted in GUI premium version.

Table 4. Voltage Control Resolution

No	Range	Resolution
1	0 – 40 V (34 V)	0.6 mV
2	0 – 20 V	0.3 mV
3	0 – 10 V	150 μ V
4	0 – 5 V	76 μ V

The current value resolution is listed in Table 5 below. The default range is 300 mA and it is a fixed value.

Table 5. Current Value Resolution

No	Range	Resolution
1	0 – 300 mA	4.5 μA

Note: This XPOW is CV only, that means user can only control the voltage, the current value will adjust automatically based on the load connected to each channel

Hardware Installation

This section describes how to install XPOW-8AX-CV-U and how to connect your Device Under Test (DUT) to the output terminals.

The steps are as follow:

1. Precondition step: connect to the DC power supply (max 36 V). Make certain that DC power supply is always 'ON'.
2. Connect a USB cable to your workstation (PC/Laptop) via a USB port.
3. Connect XPOW output to your Device Under Test (DUT).
4. Install the software/GUI (see the Software Installation section) from the flash disk, Dropbox link, and [Nicslab website](#).
5. After you install the software/GUI, then the XPOW is ready to use by switching the ON/OFF button at the front panel.

3. Software and Graphical User Interface (GUI)

Software Requirement

The GUI software is suitable with the following operating systems:

- Windows® 7 (32-bit, 64-bit).
- Windows® 10 (32-bit, 64-bit).
- Windows® 11 (64-bit).
- macOS Big Sur.
- Linux Ubuntu

Software Installation

The first step is to copy the GUI file into your hard disk. For Mac, both the GUI and Arduino must be copied inside the 'Application' folder.

Double click the icon below to install the GUI.

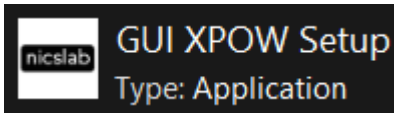

At the end step of the installation, check a 'Create a desktop shortcut'.

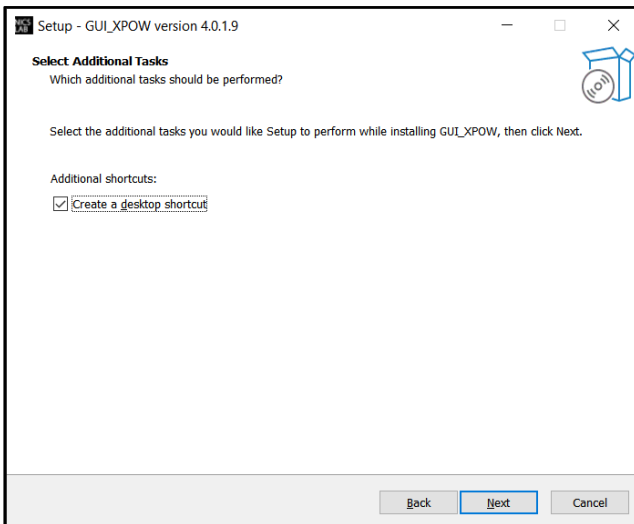

Double click the executable GUI icon (as below) on your desktop to launch the GUI.

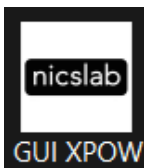

How to Detect Which COM Is Used (*Windows only*)

1. Click **Start** . Find 'Device Manager'.

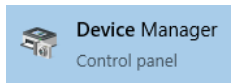

2. Find **Ports (COM & LPT)** in Device Manager.

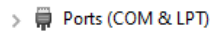

3. When XPOW is connected to the computer then there will be an Arduino Leonardo port and the COM's number. From the image below the COM number is 8.

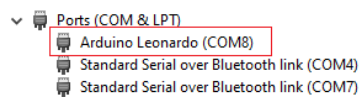

Graphical User Interface (GUI)

Start the XPOW by pressing the ON button, then you can control it by GUI, the display details are on the next page.

Note: You can also launch the GUI through programming languages such as Python, C#, LabVIEW, and Java.

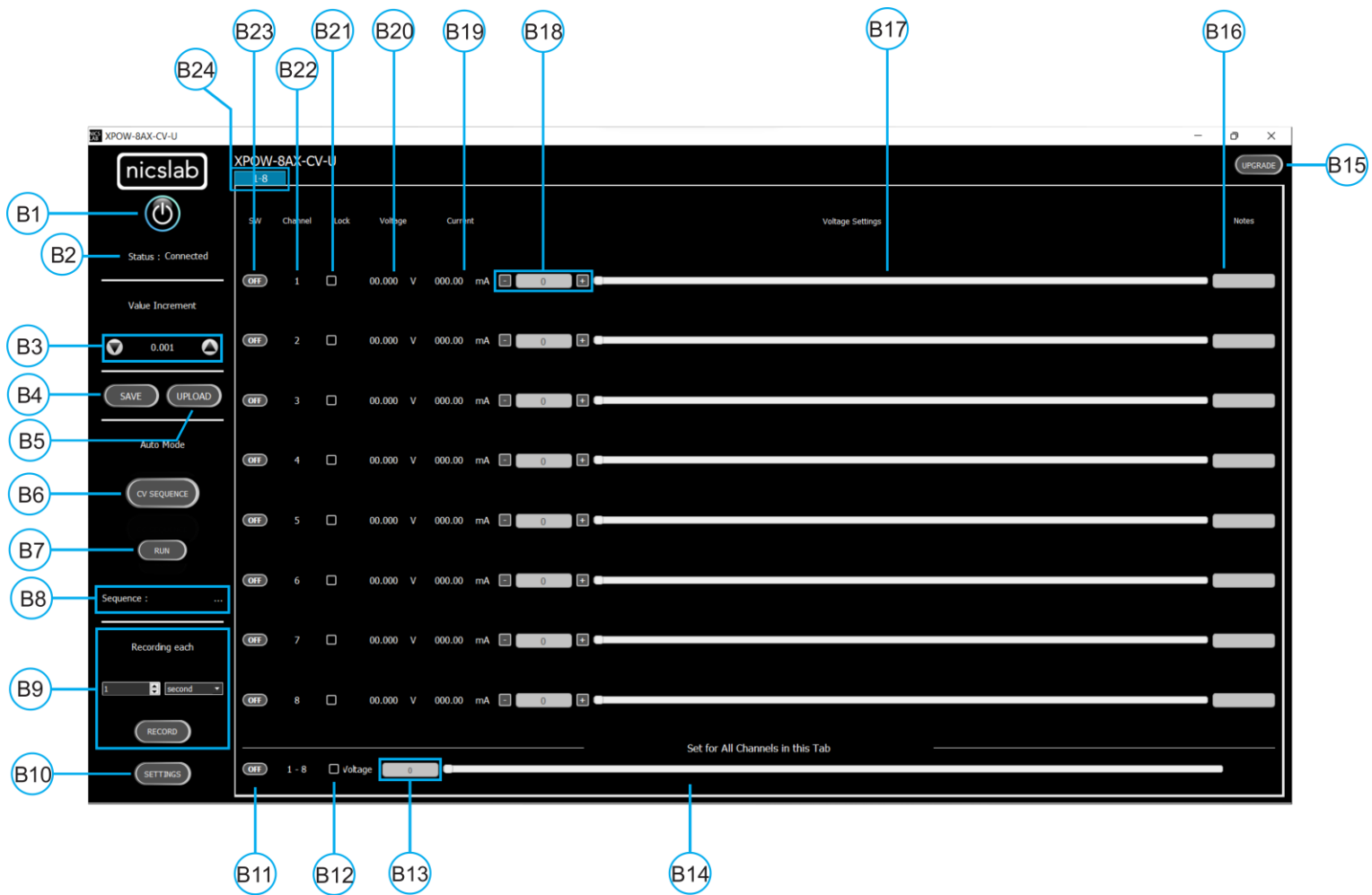

Figure 4. GUI

Note:

Callout	Description
B1	ON/OFF Switch
B2	Status of connection
B3	Increment Settings
B4	Save File Button - <i>Premium Feature</i>
B5	Upload File Button - <i>Premium Feature</i>
B6	Auto Feature Sequence: Upload Table Button I CV Mode - <i>Premium Feature</i>
B7	Auto Feature: Run Button CV Mode - <i>Premium Feature</i>
B8	Name of the Sequence - <i>Premium Feature</i>
B9	Record Data Button - <i>Premium Feature</i>
B10	Setting for: <ol style="list-style-type: none"> 1. Set Limit voltage and current values - <i>Premium Feature</i> 2. V Range (16-bit precision for every range of voltages: 5, 10, 20, 34 V) with effective voltage output range up to 34 V - <i>Premium Feature</i> 3. Set the Reading speed of Voltage and Current (Fast, Medium, Slow) - <i>Premium Feature</i>
B11	ON/OFF Button for the current Tab
B12	Enable/Disable (Lock) Channel Controller for all channels in the current tab
B13	Text area to set the voltage for all channels in the current tab
B14	Slider to set the voltage for all channels in the current tab
B15	Upgrade Button
B16	Notes - <i>Premium Feature</i>
B17	Voltage Settings Slider
B18	Voltage Value Based on Increment Setting
B19	Current Value
B20	Voltage Value
B21	Enable/Disable (Lock) Channel Controller
B22	Number of channels
B23	ON/OFF Button per Channel
B24	Tab Channel

Initializing the GUI

This section shows how to initialize the GUI:

1. Launch the GUI by double-clicking the executable GUI icon.
2. When you launch the GUI for the first time, input the 'XPOW Key' and choose the correct 'COM' port.

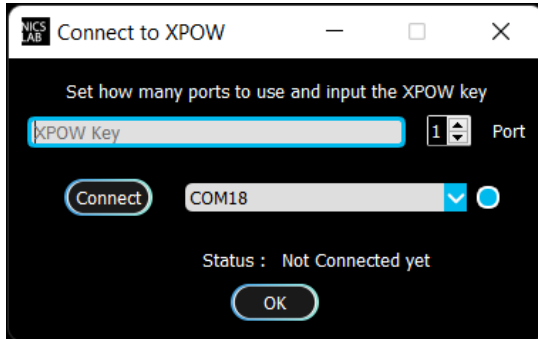

3. Press the switch button (B1) on GUI to connect it with the XPOW.



4. Turn ON (B23) on each channel to the input voltage and current values.

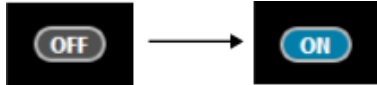

Premium Upgrade

This section shows how to upgrade the GUI to enable advanced features.

1. Press the upgrade button at the top right corner of the window

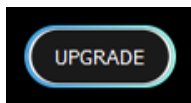

2. After the upgrade window opened, input the Premium Upgrade Key.

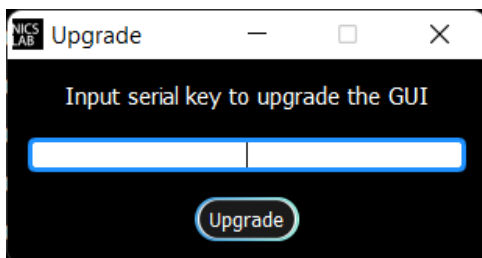

3. If your Premium Upgrade Key is valid, you will get a message that indicates a successful upgrade.

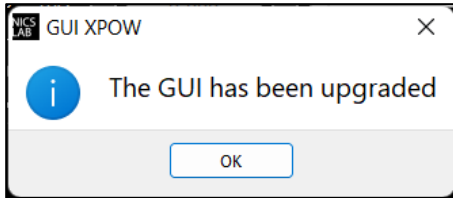

4. You can use several features that were previously locked.



The next few sections are the advanced features that are enabled after upgrading the GUI.

Constant Voltage (CV) Mode

This section shows how to do CV mode according to your aim:

To do CV mode, you need to adjust the voltage value on (B18) or slider (B17).

Important note: When you input manually the values, always press 'Enter'.



Value Increment Setting

In this setting, the value of the voltage and current can be incrementally changed from 0.001 to 1. Click the arrow to increase and decrease the value increment (B3).

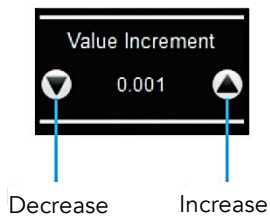

Save and Upload

The CSV file (.csv) resulted from the Save function can be uploaded again through the Upload button (B5). You may also create your own CSV file of voltage and current and upload it later.

1. To save the configuration, click the 'Save' button (B4).



2. Select a directory and write the file name.

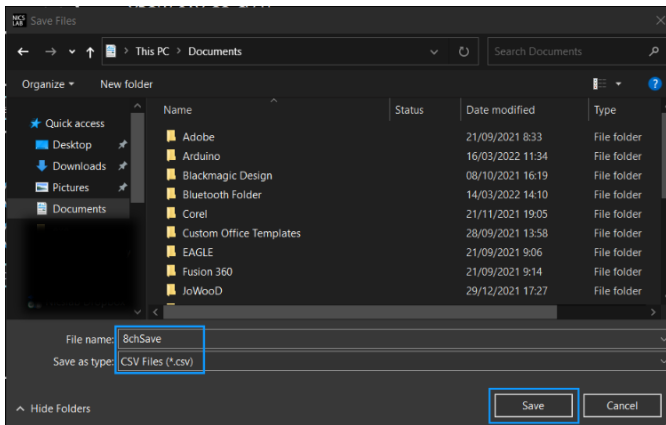

3. The file will be saved as '.csv file'.
4. Check the (.csv) file that you have saved.

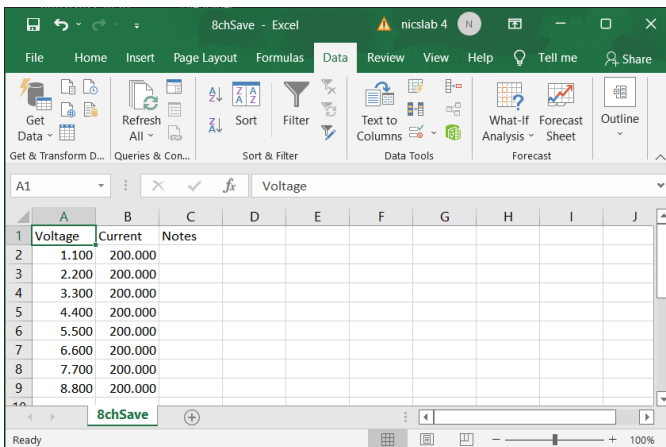

The voltage, current, and notes are recorded. If the file doesn't appear to have saved data from all channel, consider trying to open the file with another program, like Notepad, for further inspection.

5. To upload the configuration, click the 'Upload' button (B5).



6. Choose and open the intended file.

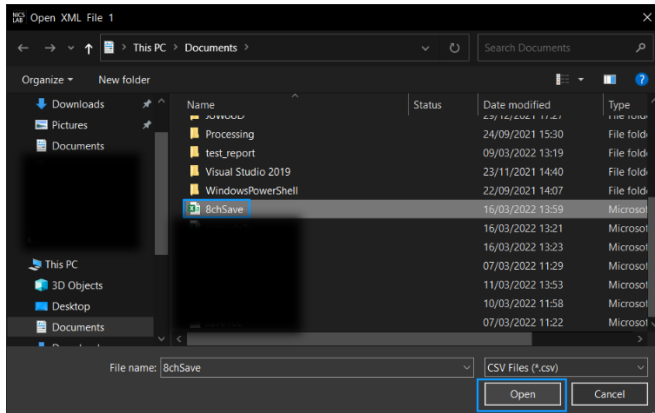

7. Then, it will upload the configuration like the previous configuration.



Sequence Automation

Sequence is the setting that automates the determined values of current (mA) or voltage (V) given the certain Delay Time (in millisecond).

1. The template of the sequence is given, then you need to input your intended values of CV Sequence (from 0 to 34 V) and Delay Time (in millisecond). Set the delay time to more than 2 seconds to have more accurate values. To have a faster response (switching time) you can set via SCPI command (see Operating XPOW through SCPI command).

	A	B	C	D	E	F	G	H	I	J
1		Seq 1	Seq 2	Seq 3	Seq 4	Seq 5	Seq 6	Seq 7	Seq 8	Note
2	Delay Time	6000	5478	4912	3409	4213	5902	6012		
3	Channel 1	5	50	0	100	150	150	0	300	Fan1
4	Channel 2	10	50	0	100	160	150	0	300	Fan2
5	Channel 3	15	50	0	100	170	150	0	300	Motor1
6	Channel 4	20	50	0	100	180	150	0	300	Motor2
7	Channel 5	25	50	0	100	190	150	0	300	Sensor1
8	Channel 6	30	50	0	100	200	150	0	300	Sensor2
9	Channel 7	35	50	0	100	210	150	0	300	Sensor3
10	Channel 8	40	50	0	100	220	150	0	300	Not Used

Note:

- A. Template given for CV sequences.
 - B. Input your intended values according to the modes (CV: 0 – 34.V)
2. Choose the CV Sequence (B6). When you click, for example, if you want to use a CV sequence, you need to open the corresponding CSV sequence file.
 3. After uploading, choose sequence mode by clicking 'Run' (B7). It will run CV Sequence depends on the .csv file that you uploaded before.

Record

'Record' (B9) keeps data on voltage and current values. You can choose how often the data is stored in a unit of time. The default value is the data will be stored each one second. The record starts by the time you click the Record button and finish when you click again the same button.

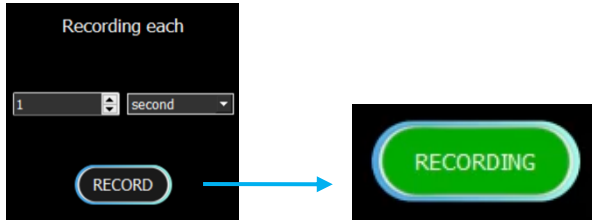

Click the same button to stop recording. After that, put the file in any directory

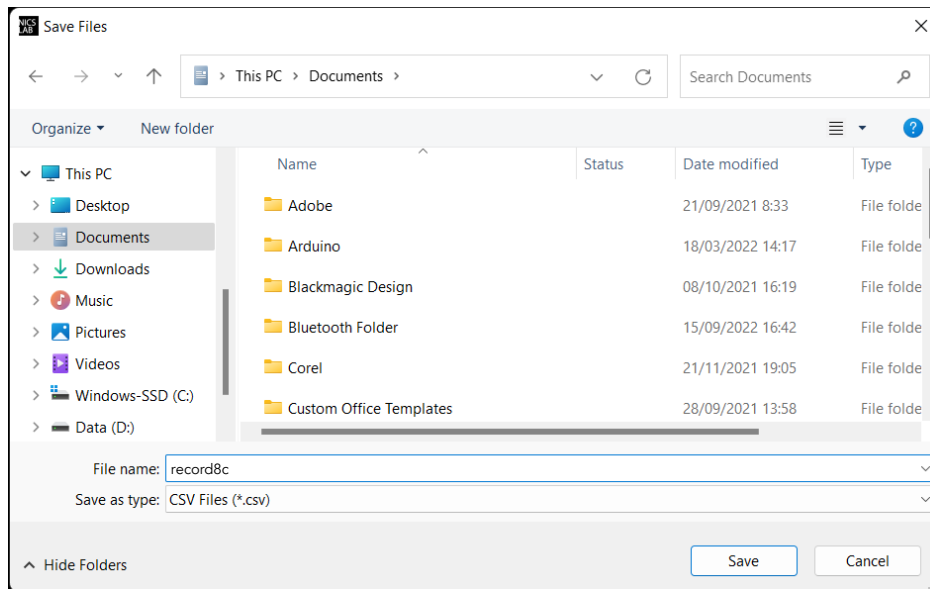

This is the output of the recorded file

A	B	C	D	E	F	G	H	I	J	K	L	M	N	O	P	Q	R	
1	Time Stamp	Voltage[1]	Current[1]	Notes	Voltage[2]	Current[2]	Notes	Voltage[3]	Current[3]	Notes	Voltage[4]	Current[4]	Notes	Voltage[5]	Current[5]	Notes	Voltage[6]	Current[6]
2	14:53:29	6.153 V	50.8 mA	Fan1	6.276 V	50.77 mA	Fan2	6.226 V	50.75 mA	Motor1	6.106 V	51.62 mA	Motor2	5.944 V	50.62 mA	Sensor1	6.095 V	50.72 nA
3	14:53:30	6.153 V	50.8 mA	Fan1	6.276 V	50.77 mA	Fan2	6.226 V	50.75 mA	Motor1	6.106 V	51.62 mA	Motor2	5.944 V	50.62 mA	Sensor1	6.095 V	50.72 nA
4	14:53:31	6.153 V	50.8 mA	Fan1	6.276 V	50.77 mA	Fan2	6.226 V	50.75 mA	Motor1	6.106 V	51.62 mA	Motor2	5.944 V	50.62 mA	Sensor1	6.095 V	50.72 nA
5	14:53:32	6.153 V	50.8 mA	Fan1	6.276 V	50.77 mA	Fan2	6.226 V	50.75 mA	Motor1	6.106 V	51.62 mA	Motor2	5.944 V	50.62 mA	Sensor1	6.095 V	50.72 nA
6	14:53:33	2.987 V	24.92 mA	Fan1	6.276 V	50.77 mA	Fan2	6.226 V	50.75 mA	Motor1	6.106 V	51.62 mA	Motor2	5.944 V	50.62 mA	Sensor1	6.095 V	50.72 nA
7	14:53:34	0.959 V	7.85 mA	Fan1	2.609 V	21.12 mA	Fan2	6.225 V	50.75 mA	Motor1	6.106 V	51.62 mA	Motor2	5.944 V	50.62 mA	Sensor1	6.095 V	50.72 nA
8	14:53:35	0.959 V	7.85 mA	Fan1	1.93 V	15.52 mA	Fan2	2.9 V	23.6 mA	Motor1	3.87 V	32.7 mA	Motor2	5.293 V	45.15 mA	Sensor1	6.095 V	50.72 nA
9	14:53:36	0.96 V	7.85 mA	Fan1	1.93 V	15.55 mA	Fan2	2.9 V	23.6 mA	Motor1	3.87 V	32.7 mA	Motor2	4.819 V	41.02 mA	Sensor1	5.818 V	48.42 nA
10	14:53:37	0.959 V	7.85 mA	Fan1	1.93 V	15.55 mA	Fan2	2.9 V	23.6 mA	Motor1	3.87 V	32.7 mA	Motor2	4.819 V	41.02 mA	Sensor1	5.818 V	48.42 nA
11	14:53:38	0.959 V	7.85 mA	Fan1	1.931 V	15.55 mA	Fan2	2.9 V	23.6 mA	Motor1	3.87 V	32.7 mA	Motor2	4.819 V	41.02 mA	Sensor1	5.818 V	48.42 nA
12	14:53:39	0.96 V	7.85 mA	Fan1	1.931 V	15.55 mA	Fan2	2.901 V	23.6 mA	Motor1	3.87 V	32.7 mA	Motor2	4.819 V	41.02 mA	Sensor1	5.818 V	48.42 nA
13	14:53:40	0.96 V	7.85 mA	Fan1	1.931 V	15.55 mA	Fan2	2.9 V	23.6 mA	Motor1	3.871 V	32.7 mA	Motor2	4.82 V	41.02 mA	Sensor1	5.818 V	48.42 nA
14	14:53:41	0.96 V	7.85 mA	Fan1	1.93 V	15.55 mA	Fan2	2.901 V	23.6 mA	Motor1	3.871 V	32.7 mA	Motor2	4.819 V	41.02 mA	Sensor1	5.818 V	48.42 nA
15	14:53:42	0.959 V	7.85 mA	Fan1	1.931 V	15.55 mA	Fan2	2.901 V	23.6 mA	Motor1	3.871 V	32.7 mA	Motor2	4.82 V	41.05 mA	Sensor1	5.818 V	48.42 nA
16	14:53:43	0.959 V	7.85 mA	Fan1	1.931 V	15.55 mA	Fan2	2.9 V	23.6 mA	Motor1	3.87 V	32.72 mA	Motor2	4.82 V	41.02 mA	Sensor1	5.818 V	48.42 nA
17	14:53:44	0.96 V	7.85 mA	Fan1	1.931 V	15.55 mA	Fan2	2.901 V	23.6 mA	Motor1	3.871 V	32.7 mA	Motor2	4.82 V	41.05 mA	Sensor1	5.818 V	48.42 nA
18	14:53:45	0.96 V	7.85 mA	Fan1	1.931 V	15.55 mA	Fan2	2.901 V	23.6 mA	Motor1	3.871 V	32.72 mA	Motor2	4.82 V	41.05 mA	Sensor1	5.818 V	48.42 nA
19	14:53:46	0.96 V	7.85 mA	Fan1	1.931 V	15.55 mA	Fan2	2.901 V	23.6 mA	Motor1	3.871 V	32.72 mA	Motor2	4.82 V	41.05 mA	Sensor1	5.818 V	48.42 nA
20	14:53:47	0.959 V	7.85 mA	Fan1	1.931 V	15.55 mA	Fan2	2.901 V	23.6 mA	Motor1	3.871 V	32.72 mA	Motor2	4.82 V	41.05 mA	Sensor1	5.818 V	48.42 nA
21	14:53:48	0.959 V	7.85 mA	Fan1	1.931 V	15.55 mA	Fan2	2.901 V	23.6 mA	Motor1	3.871 V	32.72 mA	Motor2	4.82 V	41.05 mA	Sensor1	5.818 V	48.42 nA

Settings

Click the 'Settings' button (B10).

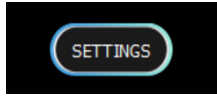

The 'Settings' feature consists of:

- Set voltage limit to limit the control voltage (B17, B18, and B20).

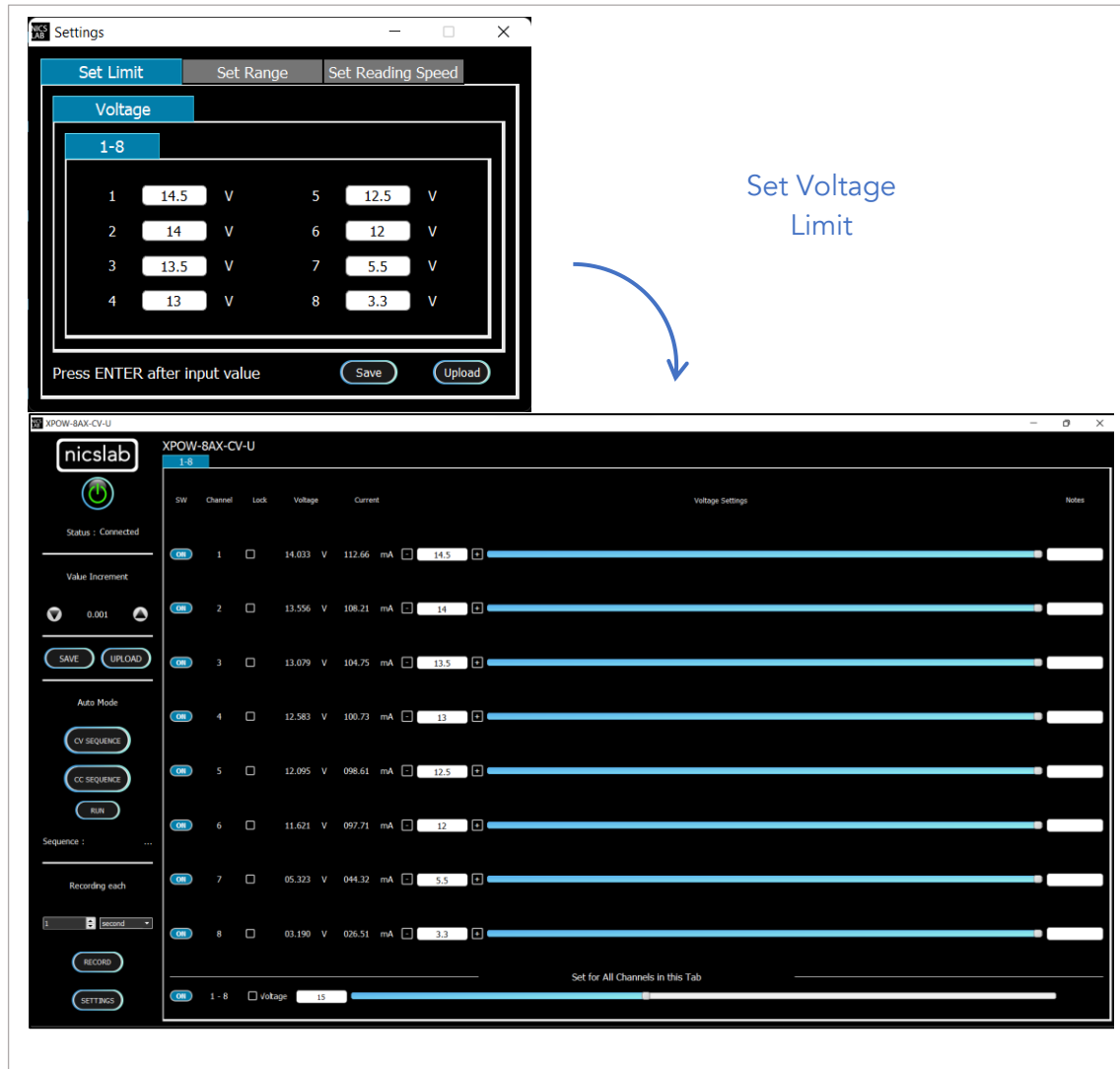

The 'Settings' window shows the 'Voltage' tab with a table of voltage limits for 8 channels. The values are:

Channel	Voltage (V)
1	14.5
2	14
3	13.5
4	13
5	12.5
6	12
7	5.5
8	3.3

The main interface shows a table of channel data and voltage sliders. The data is as follows:

SW	Channel	Lock	Voltage	Current	Voltage Settings	Notes
ON	1	<input type="checkbox"/>	14.033 V	112.66 mA	14.5	
ON	2	<input type="checkbox"/>	13.556 V	108.21 mA	14	
ON	3	<input type="checkbox"/>	13.079 V	104.75 mA	13.5	
ON	4	<input type="checkbox"/>	12.583 V	100.73 mA	13	
ON	5	<input type="checkbox"/>	12.095 V	098.61 mA	12.5	
ON	6	<input type="checkbox"/>	11.621 V	097.71 mA	12	
ON	7	<input type="checkbox"/>	05.323 V	044.32 mA	5.5	
ON	8	<input type="checkbox"/>	03.190 V	026.51 mA	3.3	

Important note: When you input the values, always press 'Enter'.

- Set range for voltage values where you can choose the voltage range to limit the voltage values. The range of voltages are 5 V, 10 V, 20 V and 34 V. Each range has 16-bit precision.

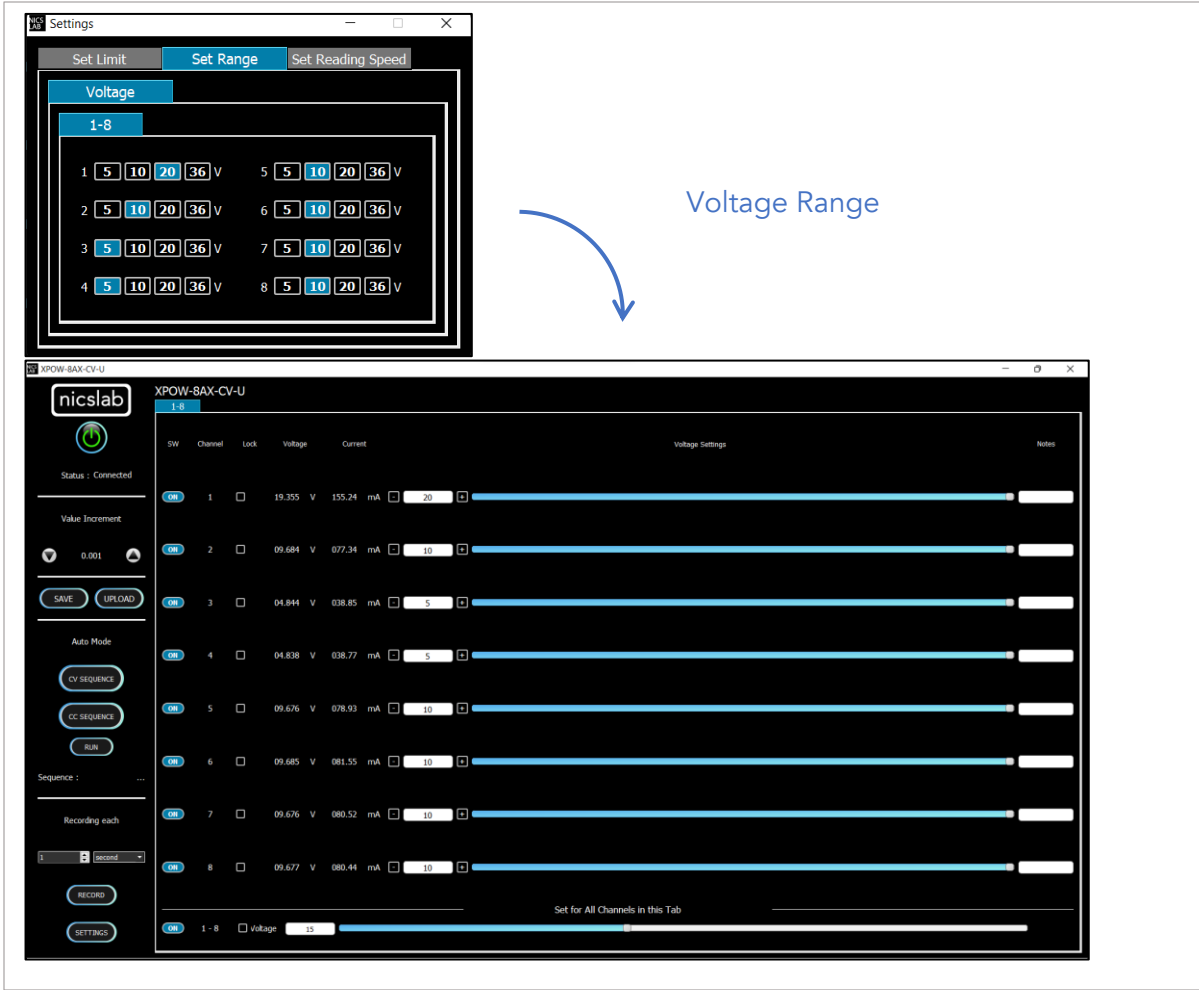

- Set reading speed for current and voltage. There are three options which is Fast, Medium, and Slow. Faster options can make conversion time smaller but the results noisier.

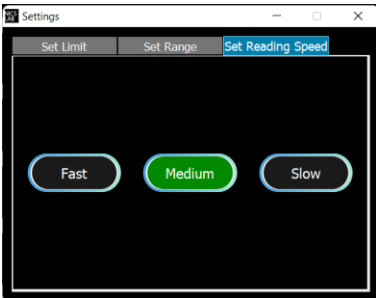

4. Operating XPOW through SCPI command

This section set guidelines to help you develop a program for any language that suits you best. The example is written in Python.

Python Installation (Example)

Please follow the steps below for dynamic programming using the SCPI command through Python via serial.

The following Python version and packages need to be installed:

1. Python 2.7 or Python 3.X (download and install the latest version from www.python.org). *Tested with Python 3.7.
2. PyCharm 2017.3.4 or the latest version (download and install the latest version from <https://www.jetbrains.com/pycharm/>).

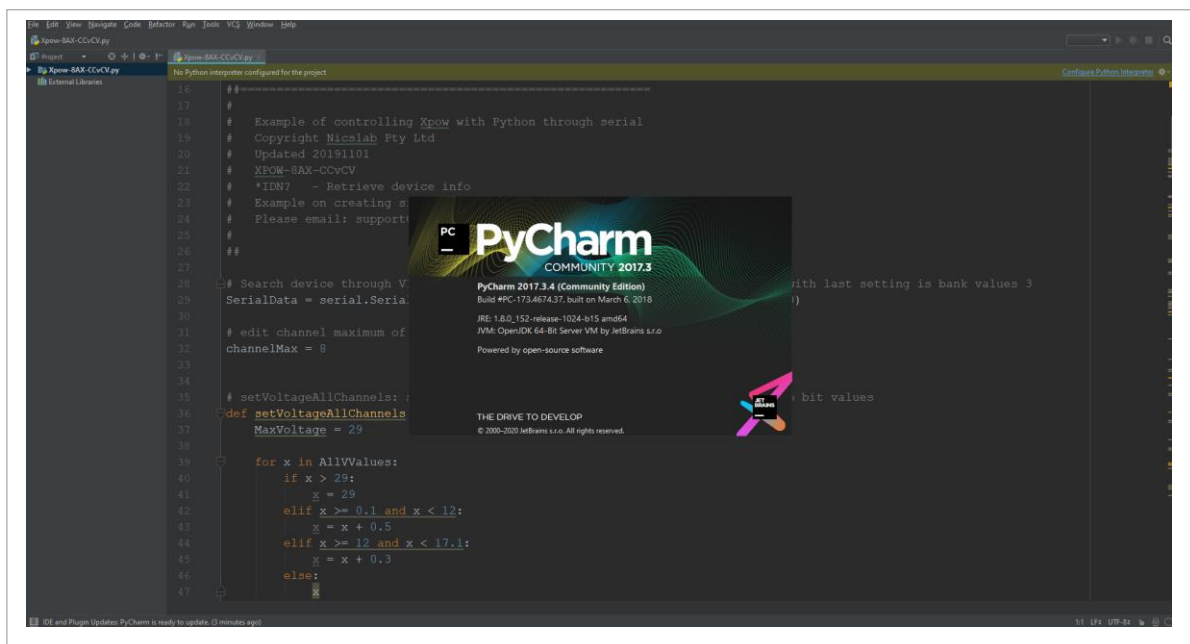

Run Python Code (Example)

To run the Python code please follow the steps below:

1. Open PyCharm software and open file example (e.g XPOW-8AX-CV-U.py)

- Configure the Python interpreter see figure below by clicking Configure Python Interpreter link on the top right-hand corner of the code, or in File >> Settings >> Project Interpreter in Windows or Preference >> Project Interpreter in Mac. Select Python 2.7 or Python 3.X in the Project Interpreter list.

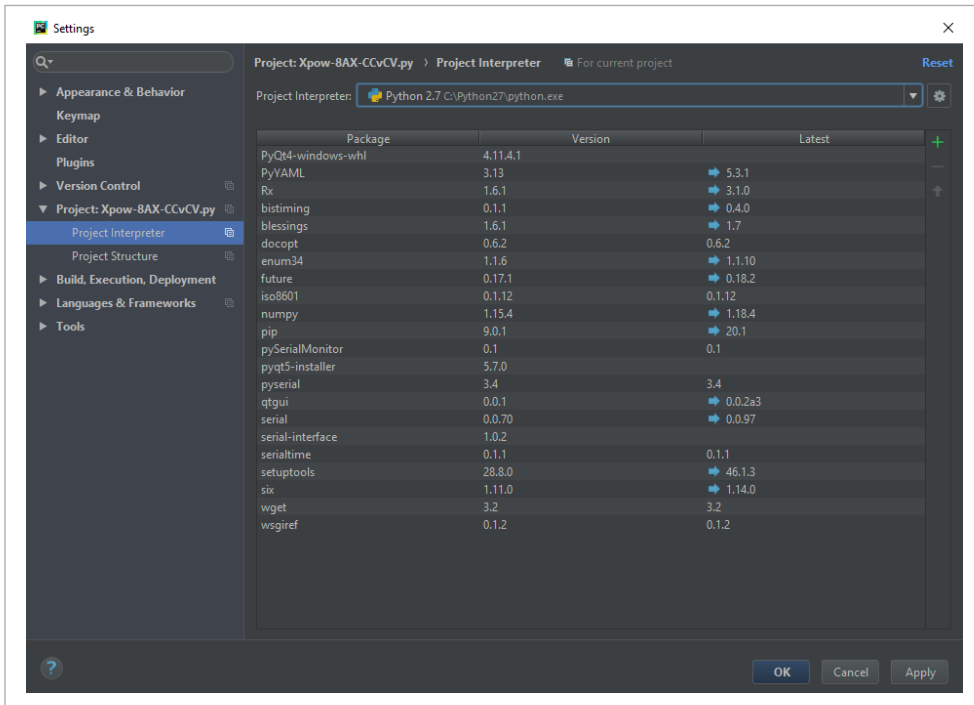

- Install additional packages: enum34, pip, pyserial, setup tools by clicking the “+” button, then search and install all the packages.

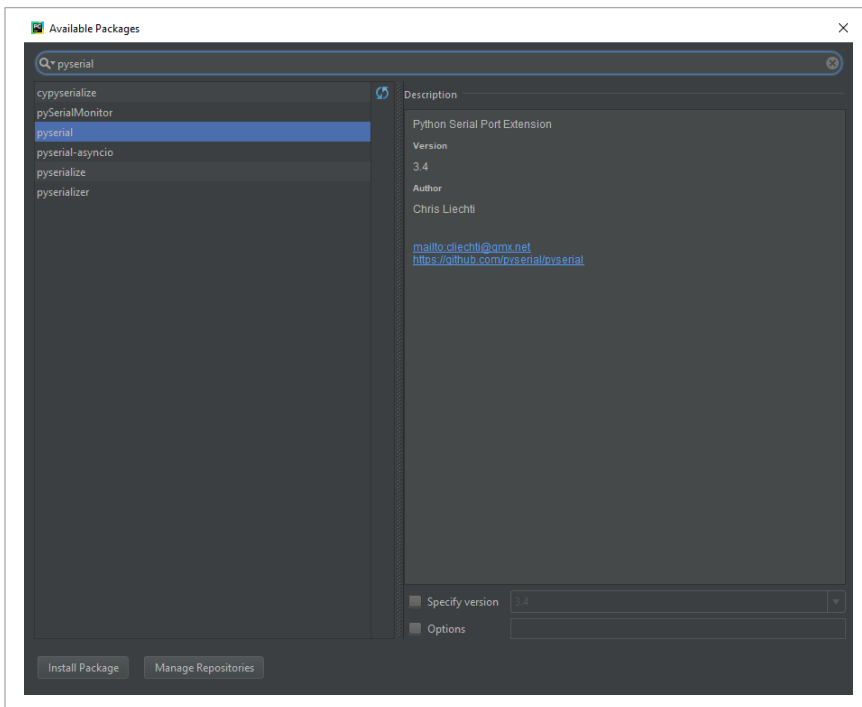

- Select Python Configuration and choose the file name.

- Run the file by clicking the green arrow button on the top right corner to test the XPOW (Please refer to the code and SCPI commands references)

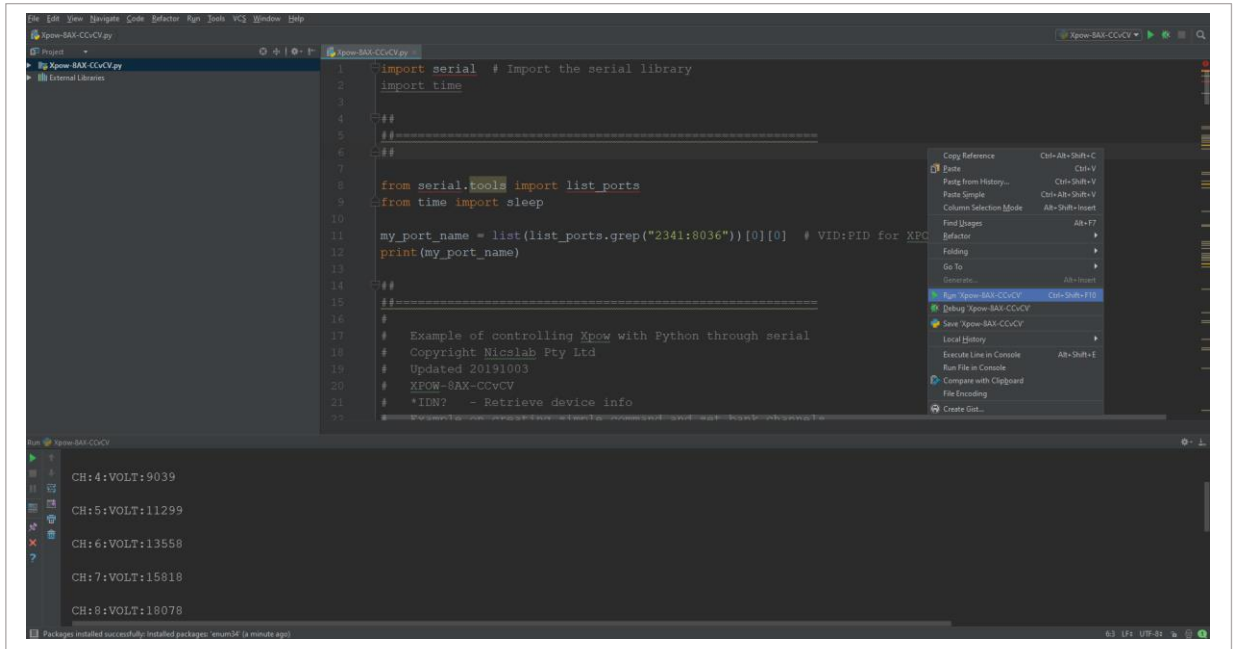

Python Function (Example)

- Constant Voltage Calibration for single channel

Calibration work by applying voltage below the limit that we set in this function

```
cvCalibrationSingleChannel(channel, vcal)
```

channel (int): channel number

vcal (float): 0 - 34 V

Example:

Calibration with DUT connected to channel 1, voltage limit 0.5 V.

```
cvCalibrationSingleChannel(1, 0.5)
```

- Constant Voltage Calibration for all channel

Calibration work by applying voltage and current below the limit that we set in this function

```
cvCalibrationAllChannel(vcal)
```

vcal (float array): 0 - 34 V

3. Set ON for single channel

```
setChannel(channel, voltageVal)
```

channel (int): channel number

voltageVal (float): 0 - 34 V

4. Set ON for all channels

```
setVoltageAllChannels(AllVValues)
```

AllVValues (float array): voltage values in array (V)

Example:

```
AllVValues = [20.1, 2.5, 13.0, 4, 5, 10.5, 9.5, 22]
```

5. Set Range for all channels

```
setRangeAllChannels(AllRangeValues)
```

AllRangeValues (Int array): voltage range index values in array

Array Index:

0: 0 - 5 V

1: 0 - 10 V

2: 0 - 20 V

4: 0 - 34 V (with 36 power supply)

Example:

```
AllRValues = [1, 0, 1, 0, 2, 1, 0]
```

6. Set GPIO digital output

```
setGPIO(index, value)
```

Index (int): Index of GP pin (12, 13, 16, 19, 26)

Value (string): "HIGH" or "LOW"

Example:

Set GP26 output to digital high

```
setGPIO(26, "HIGH")
```

7. Set Measurement Config

```
measurementConfig(voltConvTime, currConvTime, averaging)
```

```
voltConvTime(Int uS) : Voltage measurement conversion time
```

```
currConvTime(Int uS) : Current measurement conversion time
```

```
averaging(int) : count of samples to be averaged
```

8. Set OFF for single channel

```
setOff(channel)
```

```
channel (int) : channel number
```

9. Set OFF for all channels

```
setOffAllChannels(maxChannel)
```

```
maxChannel (int) : maximum number of channels in XPOW
```

10. Read real-time value for single channel

```
readChannel(channel)
```

```
channel (int) : channel number
```

11. Read real-time value for all channels

```
readCommand(maxChannel)
```

```
maxChannel (int) : maximum number of channels in XPOW
```

12. Automatic Setting for One Channel

Change and record the value in one channel for every time duration. The result will be saved as a CSV file.

```
sweepOne(channel, seqValueV, seqValueC, duration)
```

```
channel (int) : channel number
```

```
seqValueV (float array) : values for the voltage (V) for one channel in array.
```

```
seqValueC (float array) : values for the current (mA) for one channel in array
```

```
duration (int) : waiting time to change to the next value in seconds
```

Example:

```
channel = 1
```

```
seqValueV = [20.1, 2.5, 13.0, 4, 5, 10.5, 9.5, 22]
```

```
seqValueC = [100, 150, 100, 50, 200, 10, 10]
```

```
duration = 5
```

SCPI Commands

The XPOW can be controlled using Standard Commands for Programmable Instruments (SCPI) with 115200 baud rates.

Description: Constant Voltage Mode Calibration for single channel

Format:

```
CH:[n]:CALIB:[V Values]:[C Values]
```

Description: Set output voltage for single channel

Format:

```
CH:[n]:VOLT:[VOLT VALUES]
```

Result:

```
<CH:1:VOLT:[VOLT VALUES]:OK>
```

Example 1: Set the output voltage of channel 1 to 34 V

```
CH:1:VOLT:34 (set the output voltage of channel 1 to max 34 V)
```

Result:

```
<CH:1:VOLT:34:OK>
```

Example 2: Set the output voltage of channel 3 to 20V

```
CH:3:VOLT:20 (set the output voltage of channel 3 to 20 V)
```

Result:

```
<CH:3:VOLT:20:OK>
```

Display real-time data for single channel

Format:

CH: [n]:VAL?

Description: Display voltage and current real-time value of channel n.

Result:

<val: [n]:VOLTAGE VAL:CURRENT VAL>

Example:

CH:1:VAL?

Result:

<val:1:6.101:100.211>

Set output voltage for a group of channels

Format:

CH: [m-n]:VOLT: [0-Vmax]

Description: Set the output voltage of channel m to channel n to [0-34 V].

Note: $1 \leq m < n \leq \text{Channel Max}$

Example:

CH:1-8:VOLT:20 (set outputs of channel 8 to channel 10 to 20 Volt)

Set measurement config

Format:

MEASCONF:VoltConvTime:CurrConvTime:Averaging

Description: Set measurement conversion time in μs and average sample counts.

Result:

MEASCONF:VoltConvTime:CurrConvTime:Averaging >> OK!

Set pin GPIO

Input

Format:

GPIO: [PIN NAME]

Description: Read the GPIO pin

Example:

GPIO:PD4

Result :

GPIO:PD4

Output - High

Format:

GPIO: [PIN NAME] :HIGH

Description: Set the GPIO pin to high (5V)

Example:

GPIO:PF5:HIGH

Result : GPIO:PF5:HIGH

Output - Low

Format:

GPIO: [PIN NAME] :LOW

Description: Set the GPIO pin to low (0V)

Example:

GPIO:PF5:LOW

Result :

GPIO:PF5:LOW

Retrieve device information

Format:

*IDN?

Description: Get information about the device.

Example:

*IDN?

Result :

*IDN? >> XPOW-8AX-CV-U, Nicslab Ops, Inc.

Set range

Format:

CH: [n] :SVR: [0-3]

Note:

0 -> 5 V

1 -> 10 V

2 -> 20 V

3 -> 34 V

Default: 3

Result:

<CH: [n] :SVR: [RANGE VALUES] :OK>

Example 1: Set the range of channel 1 to maximum.

CH:1:SVR:3 (set the range of channel 1 to max 34 V)

Result:

<CH:1:SVR:3:OK>

5. System Shutdown

This section describes how to shut down the XPOW-8AX-CV-U.

In the case of using GUI, the steps are as follows:

1. Set OFF all the channel in the GUI.
2. Press the ON/OFF Button in GUI (B1, Figure 4). It will change the color of the button from green to grey.
3. Close the GUI application.
4. Press button A1 (Figure 3).
5. Turn off the DC Power Supply.

In the case of using SCPI Command, the steps are as follows:

1. Use `setOff(channel)` function to set off the channel used before.
2. Press the button A1 (Figure 3).
3. Turn off the DC Power Supply

NOTE : Once the soft shutdown occurred, all led will be turned off. To use XPOW-8AX-CV-U after a soft shutdown, just switch off and switch on again (restart) the XPOW-8AX-CV-U.

6. Troubleshooting

Please use the following guidelines to identify a particular problem. If the solution does not rectify the problem, contact us at support@nicslab.com.

Table 6. Troubleshooting

Problem	Cause	Solution
Front end light off when switch turned on	No USB connection	Check USB connection to Laptop/PC
The Blue light off when the software active or the software freezes	Initialization failed	Restart the software / unplug - plug the USB connector, or Press Reset Button
No channel output detected at device under test	Connection failed	Check metal pad check point to intended channel
No USB port detected at device manager	No USB connection	Turn on the XPOW-8AX box before running the application, and check USB connection Check the Arduino Driver if it is installed in the computer. Check to another USB port.
Unable to upload the file	File format problem	Make sure the file format is .csv
No value after upload the file	File problem	Check the file content, make sure there is no blank space on each row.
Unable to use Auto Mode feature	File format problem	Check the file format, it should be a csv file. Check content format
Display value unstable in GUI	Serial Connection Failed	Change USB cable. Use low noise USB cable.

7. Warranty

Nicslab warrants the hardware and software designed by Nicslab to work accordingly, fulfilling the highest standard of quality product. Nicslab is not liable for consequential or incidental damages or for errors in subject to misuse, neglect, accident, modification, use in critical operation, or has been soldered or altered in any way outside stated by us or unauthorized maintenance.

Nicslab retains to change the material and technical data of this manual at any time without notice, in future editions.

Please do not hesitate to contact us at support@nicslab.com if you would like to have more information on warranty or return and refund policy.

8. Compliance

This product complies to the requirements of the European Union's *Conformite Europeenne* (CE) and Restriction of Hazardous Substances in Electrical and Electronic Equipment (RoHS) Directive 2015/863 (RoHS3). The certificates can be accessed [here](#).

9. Contact

United States

Nicslab Ops, Inc.

228 Hamilton Avenue, 3rd Floor, Palo Alto

Silicon Valley, CA, 94301

Phone: +1 (650) 521-9982

Email: support@nicslab.com

Website: www.nicslab.com

Indonesia

PT. Nicslab Global Industri

Wisma Monex 9th floor

Jl. Asia Afrika No. 133-132, Bandung West Java 40112

Phone: +62 22 8602 6854

Email: nicslab.id@nicslab.com

Book a meeting [here](#).